

BULLETIN OF THE MUSEUM OF FINE ARTS

VOLUME XXX

BOSTON, AUGUST, 1932

NUMBER 180

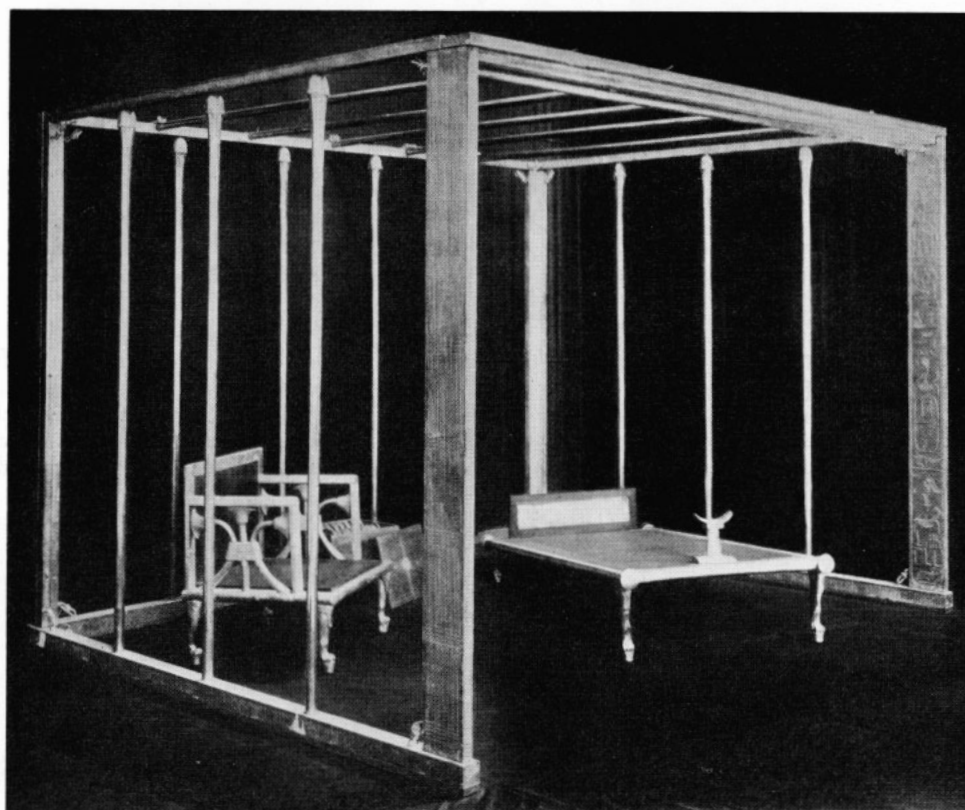

The gold-cased bed canopy of Queen Hetepheres I, mother of Cheops, containing her arm-chair, jewel-box, and bed with headrest

FOUND BY THE JOINT EGYPTIAN EXPEDITION OF HARVARD UNIVERSITY AND THE MUSEUM OF FINE ARTS, AND NOW EXHIBITED,
AFTER RECONSTRUCTION, IN THE MUSEUM AT CAIRO

PUBLISHED BI-MONTHLY

SUBSCRIPTION 50 CENTS

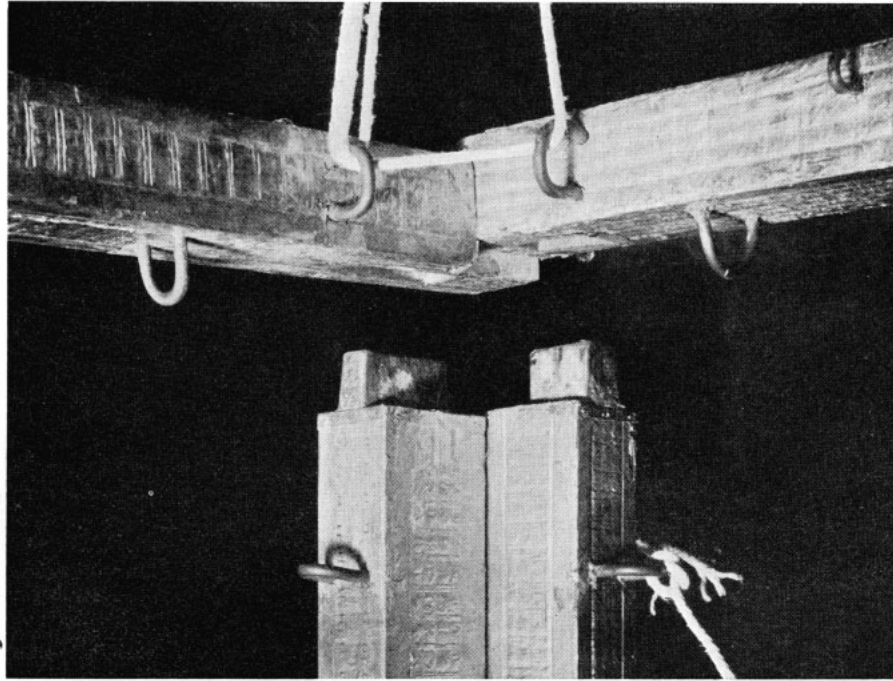

Upper left-hand back corner of canopy from inside, opened to show copper-cased tenons and copper sockets in roof beams

The Bed Canopy of the Mother of Cheops

THE gold-cased bed canopy of Queen Hetepheres I, the mother of Cheops, was delivered by the Harvard-Boston Expedition to the Cairo Museum on March 10, 1932. The canopy consists of a framework of three floor beams, four upright posts of which two form the jambs of one side which was open, four roofing beams supported by ten slender poles, and five roofing poles. The inscription in relief on each door-jamb gives the titles and names of King Sneferuw who presented the canopy to his wife. The inscription reads: "The Horus Nebma'at, the great god, endowed with life, endurance (twice) and power (twice), the King of Upper and Lower Egypt, lord of the two crowns, Nebma'at, the Golden Horus, Sneferuw (in a cartouche), lord of the *hpt* (-ceremony?), the Golden Horus, foremost of the places of the god forever." The simplicity and light grace of the whole canopy testify to the artistic sense of the Egyptian craftsmen of the reign of Sneferuw (about 3000 B. C.).

The whole canopy measures 3.20m. in length by 2.50m. in width and 2.20m. in height. Around the tops of the roofing beams on all four sides runs a row of small hooks on which the linen curtains were hung, and these were tied to a row of small staples which were outside the floor beams on three sides. The bottom of the curtain was free across the doorway to permit entrance and exit. The roof was probably also shielded by a curtain which passed under the roofing poles. Thus the

queen, when in her bed chamber, was screened from view and saw only a white cubicle around her. The bed with its mattress stood along the back of the canopy, with the headrest lying on it as is shown by the pictures of several such canopies carved on

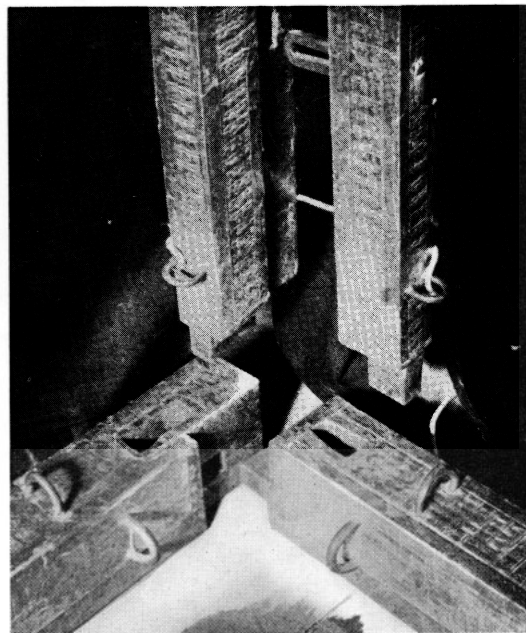

Back right-hand lower corner from inside opened to show copper-cased tenons and bearing surfaces, copper sockets in floor beams, copper staples, and scarab tie

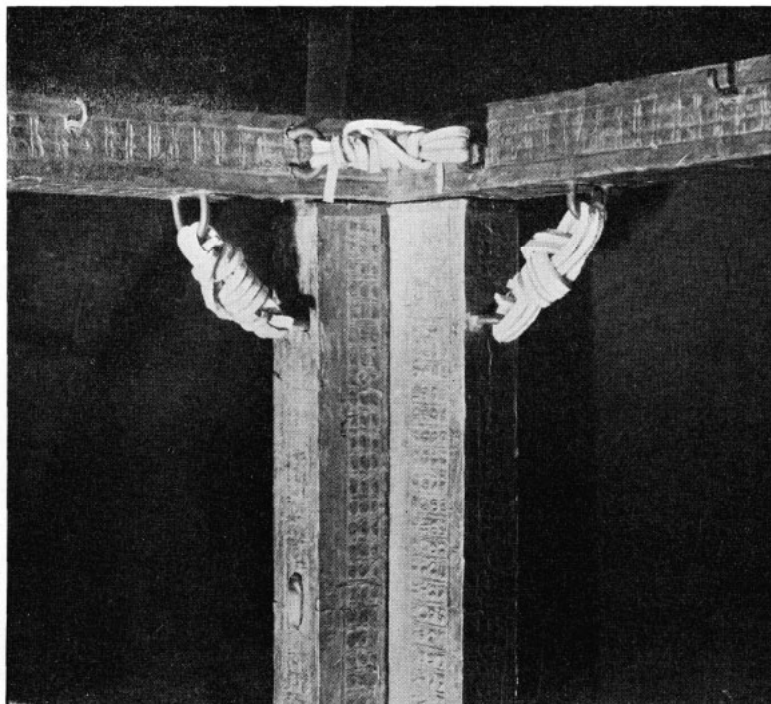

Upper left-hand back corner from inside with tenons inserted into sockets and with thong ties fastened to copper staples

the walls of offering chapels of the pyramid age. The bed and the headrest are in the Cairo Museum and will be placed in the canopy. This is the only complete example of an Old Kingdom bed canopy ever recovered. The late Mr. C. M. Firth found

the remains of a similar canopy in the tomb under the southern boundary wall of the Zoser pyramid, but this was too decayed for reconstruction.

The secret tomb of the mother of Cheops was found in March, 1925, and cleared in 1926-27 by the staff of the Harvard-Boston Expedition. The canopy was lying dismounted, the majority of the parts on the alabaster sarcophagus but some of them fallen down behind it. The wood had been destroyed by fungus but the gold sheeting which covered the wood was perfectly preserved (except for a few ancient tears). The twenty-five different pieces of which the canopy is composed were joined by tenons and sockets in which the tenons fitted. These parts were all cased in copper to form practical bearing surfaces. At each of the four corners the joints were further secured by heavy copper staples bound together by twine or rawhide thongs. The copper staples were all found attached to the gold casing. An attempt to clean these was made by Mr. Lucas but it was found that many of them were too corroded to be used again. It was therefore decided to have them reproduced in new copper. The restoration was first begun by the construction of a half-sized model made by the staff. The reconstruction of the final model was begun by Mr. W. A. Stewart after he had finished the carrying-chair, the bed, the arm-chair, the jewel-box, and the headrest. Except for some of the woodwork and part of the copper fittings, the canopy as it now stands is the work of Mr. Bernard Rice, using the expedition records, and was begun in September, 1930, and finished in February, 1932.

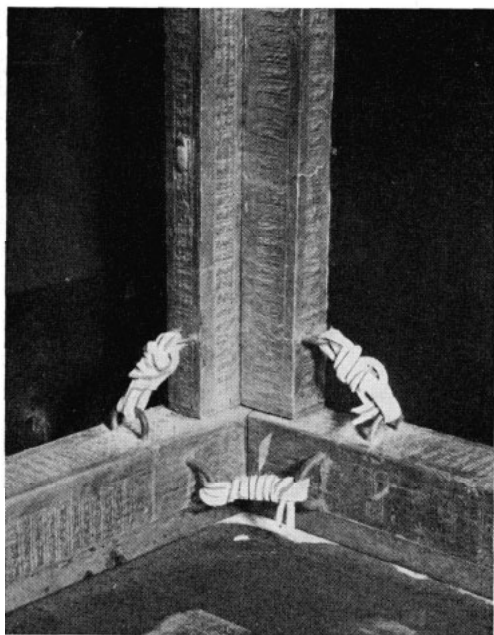

Back left-hand lower corner from inside showing the joined uprights set into the sockets of the floor beams, and the thong ties bound to the copper staples

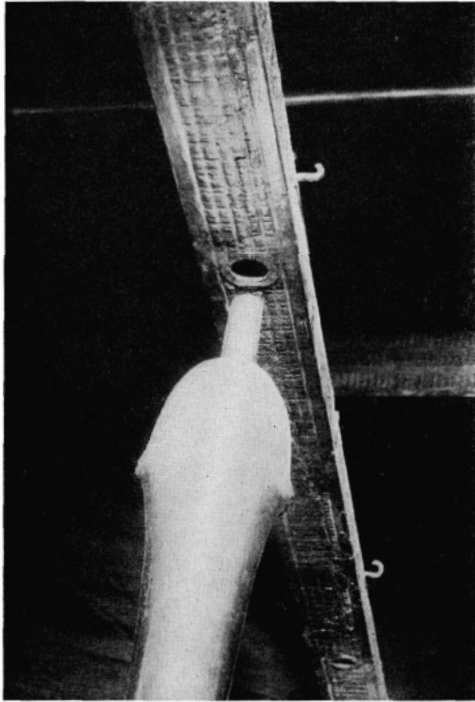

Upper end of a column with copper-cased tenon to fit copper socket in roof beam. Note curtain hooks in roof beam

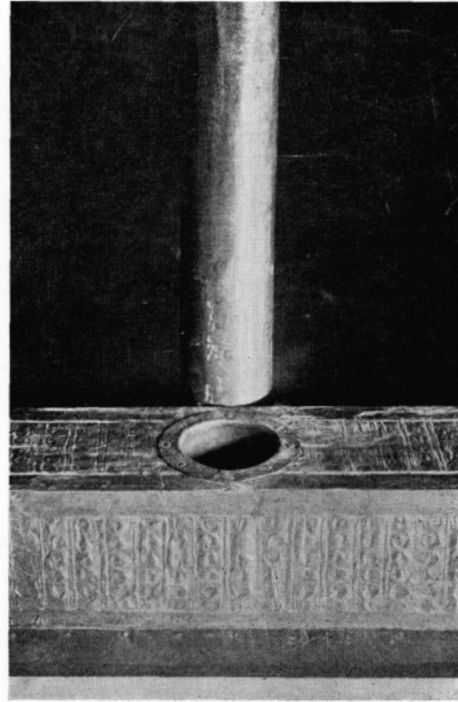

Lower end of a column showing copper ferrule fitting into copper socket in floor beam

The canopy was actually a portable bed chamber of Queen Hetepheres, presented to her by her husband Sneferuw. It can be taken down in about fifteen minutes and set up again in about the same time. There can be no doubt that this canopy was transported for the use of the queen whenever the king changed his quarters from palace to palace.

The ancient construction of the canopy was as follows. The wooden parts of the canopy were first prepared and carved with the inscriptions and

mat-designs which covered all the exposed surfaces. The tenons and sockets were cut in the wood, perhaps before carving the surfaces. After that the heavy copper staples were driven into and through the beams at the proper places and the ends hammered down on the other side. These ends were sunk in the wood and covered with plaster to conceal them from view. Then the gold sheeting, which varies in thickness, was laid over the wood and hammered to fit the carved hieroglyphics and mat-



Front right-hand lower corner of jamb showing copper-cased tenon of jamb and copper socket in floor beam

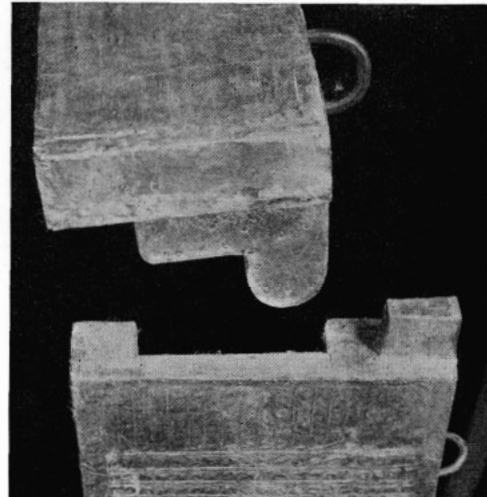

Front right-hand upper corner of jamb from outside showing copper casing of end of front beam



The two door-jambs of the canopy, each with an inscription in relief giving the titles and names of King Sneferu, who presented the canopy to his wife, Queen Hetepheres I.



Front upper left-hand corner of jamb from inside, showing thong ties attached to copper staples

designs. The details of the hieroglyphs were added with a pointed tool. Where there was a staple, the gold sheet was cut out so that the staple slipped through the slot. The slot was then repaired with a small piece of gold sheet. At this point the copper sockets and tenon-sheaths were fitted to the tenons and sockets cut in the wood and nailed to the wood with small copper tacks which passed through the underlying gold sheeting. The gold had of course been cut away around the tenons and socket-holes. The gold casing of the long beams and posts was composed in general of one single sheet, but in two cases there were two sheets overlapping at the edges. The long floor beam at the back had been covered with a thinner sheeting which appeared to have been pieced together, and was worn. The smaller hooks and staples were driven through the gold.

The ten tent-pole supports (columns) around the sides were of especially heavy gold. The shaft was a tube made by rolling a single sheet into cylindrical form and welding the edges together. The top was widened to fit the lower half of the bulb (capital). The top of the bulb is a separate sheet hammered to fit the top of the wooden bulb and nailed to the lower half with tiny gold tacks which pass through the overlapping edges of both pieces and into the wood. The cylindrical part was usually split by the swelling of the wood when the moisture first entered the burial chamber.

The roofing poles were cased in the same way as the straight stems of the columns. One of these which had been cracked or broken in two was repaired by slipping a tube of copper over the break and nailing it with small copper tacks to the wood on both sides of the crack or break. The gold sheet over the copper was thinner than usual so

that the break probably occurred after the canopy had been completed.

The front roofing beam is composed of two pieces of wood,—a rectangular beam with an L-shaped section, and a cylindrical bar underneath. These two pieces were joined together by flat wooden dowels and also by long copper staples. The upper edge of the two inscribed jambs, which were cut to the section of the front roofing beam, had the edges of the inscribed strips protected with a heavy gold band, nailed with gold tacks to the jambs.

The two back corner posts were composed each of two upright beams completely covered with gold even on the surfaces which were fitted against each other. The two parts of each beam were fastened

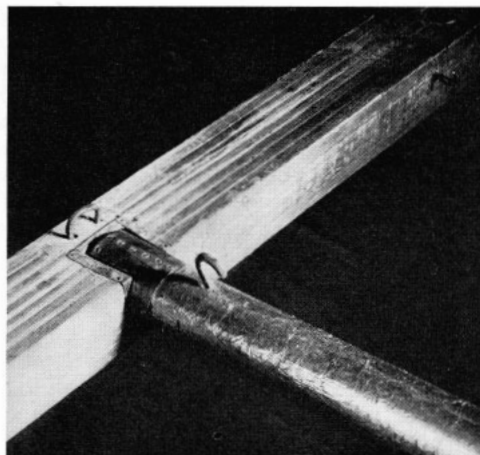

One of five roofing poles, all alike at both ends, with copper-cased tenon in copper socket and with copper staple and hook

together by three slot-bolts of ingenious form. The end of each bolt, where it showed on the inside, was carved in the form of the long beetle known from the amulets of the Old Kingdom. The flat copper bolt had a long slot. In the inner post the end of the slot was held by a copper pin counter-sunk in the inner face of the beam. The bolt passed through both beams and protruded behind the back post. Here a heavy sloping copper pin with a large head was driven into the slot, drawing the two beams tightly together. The back face of the back post was protected by a copper disc (washer) which fitted over the protruding end of the slot-bolt.

On the backs of these two corner posts are three large staples in each, the purpose of which is obscure. Mr. Rice suggests that they may have been used for fastening the canopy to the wall of the room in which it stood.

When the burial chamber was first opened, the name of Sneferuw was read on a flat object lying on the coffin beside the parts of the canopy. When this flat object was examined and removed in December, 1926, it was found to be a wooden box incrustated with gold and pieces of faience. The box, which measured 159.5 cm. long by 23.5 cm. wide and 20 cm. high, had been set on the western edge of the sarcophagus and had collapsed in place. The box had been empty and the wood was reduced to a coarse brown powder. This box had, inlaid in the gold sheeting which covered the top, the sides, and the two ends, the titles and names of Sneferuw. On each end was a seated figure of the king, inlaid as the rest of the box. The box was empty when it was placed in the secret tomb, but in the boxes along the wall was decayed linen of the fine quality required for the canopy curtains. It would thus appear that the canopy with its curtains had been set up in the original tomb at Dahshur and dismantled for transfer to Giza. The curtains, which were probably pulled down by the thieves, would have been gathered up with the other rubbish on the floor and placed in the boxes in which all this material was transported to Giza. But it is probable that the incrustated box was used to contain the curtains. It is too small to have held the bed mattress. The canopy and this box were the only objects found in the tomb which bore the name of Sneferuw. On the other inscribed objects (the carrying-chair, the gold discs, and an inlaid board) the queen bears the title of "king's mother," which proves that these objects were presented by her son Cheops. Cheops' name was read only on the mud sealings with which the vessels and receptacles had been sealed, and in particular on the alabaster Canopic chest which still contained the water in which the wrapped packages of entrails had been preserved (3% solution of natron). The next work of reconstruction will be that of the curtain box. But there remain a number of inlaid boards of great interest to be restored to their original form.

We have not been able to obtain an expert

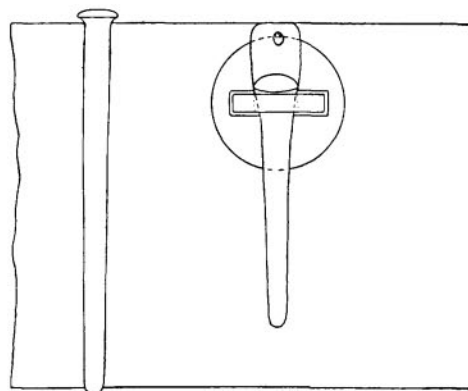
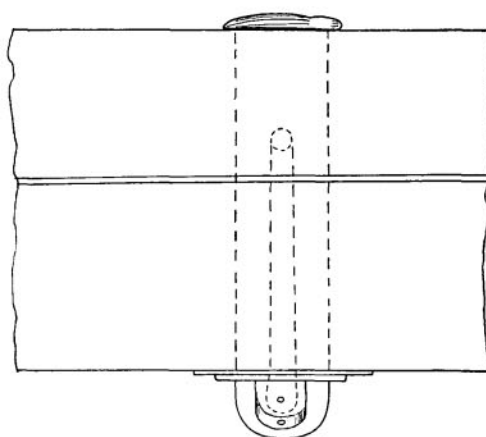
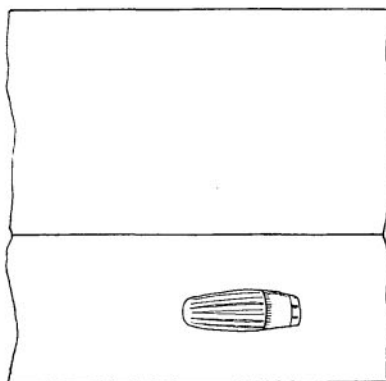

Diagrammatic drawing of a slot-bolt with head of beetle form

opinion on the nature of the wood used in the canopy, but it was probably cedar of Lebanon. It is recorded on the Palermo Stone under the year X + 2 that Sneferuw brought forty shiploads of cedar to Egypt. The next year he built a hundred-ell ship of cedar and the year after that he made cedar doors for his palace. It may well be that the frame of our canopy was constructed of cedar from these same forty shiploads mentioned in the Palermo Stone.

REISNER.