

*G 7111 C Chamber. Alabaster*

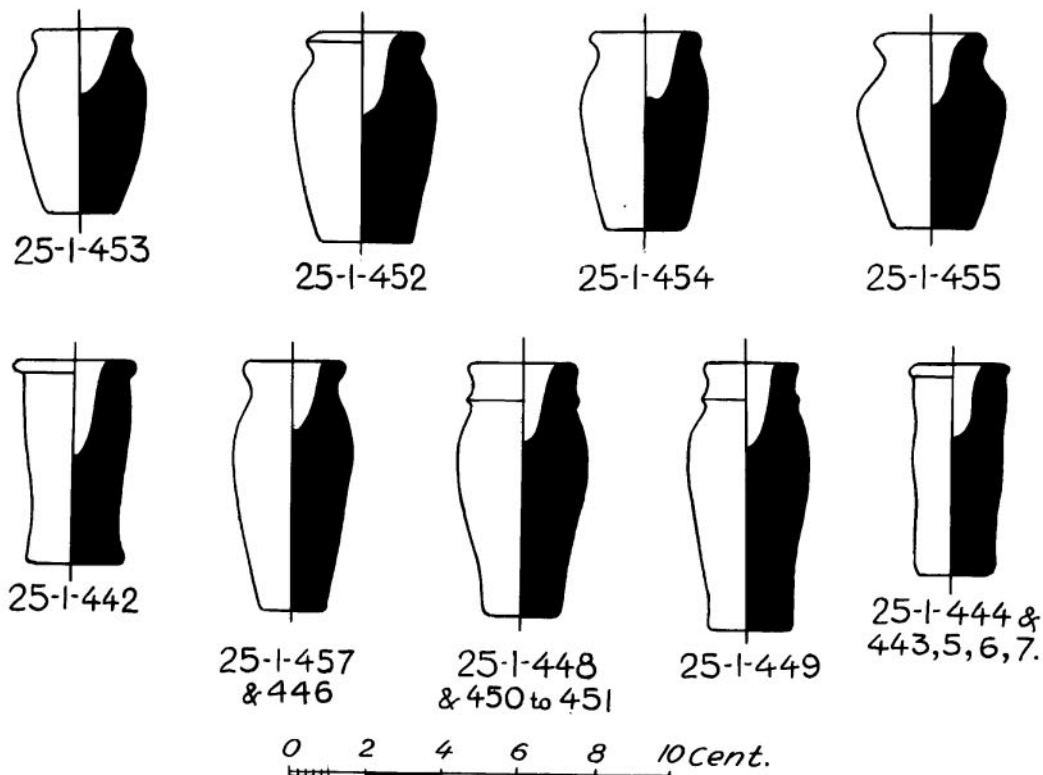

*G 7111 C Chamber. Alabaster.*

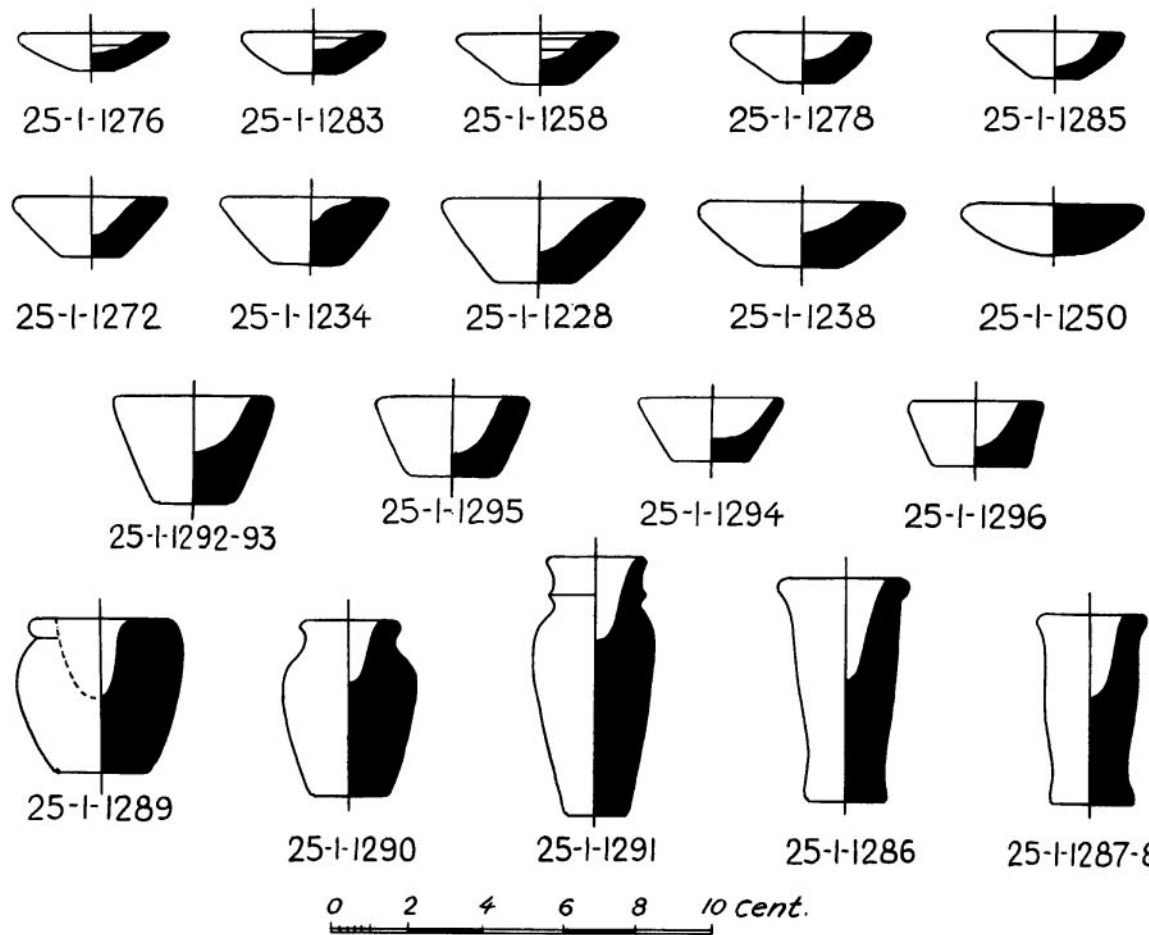

*G 7111 D Chamber. Alabaster*

G 7111 E

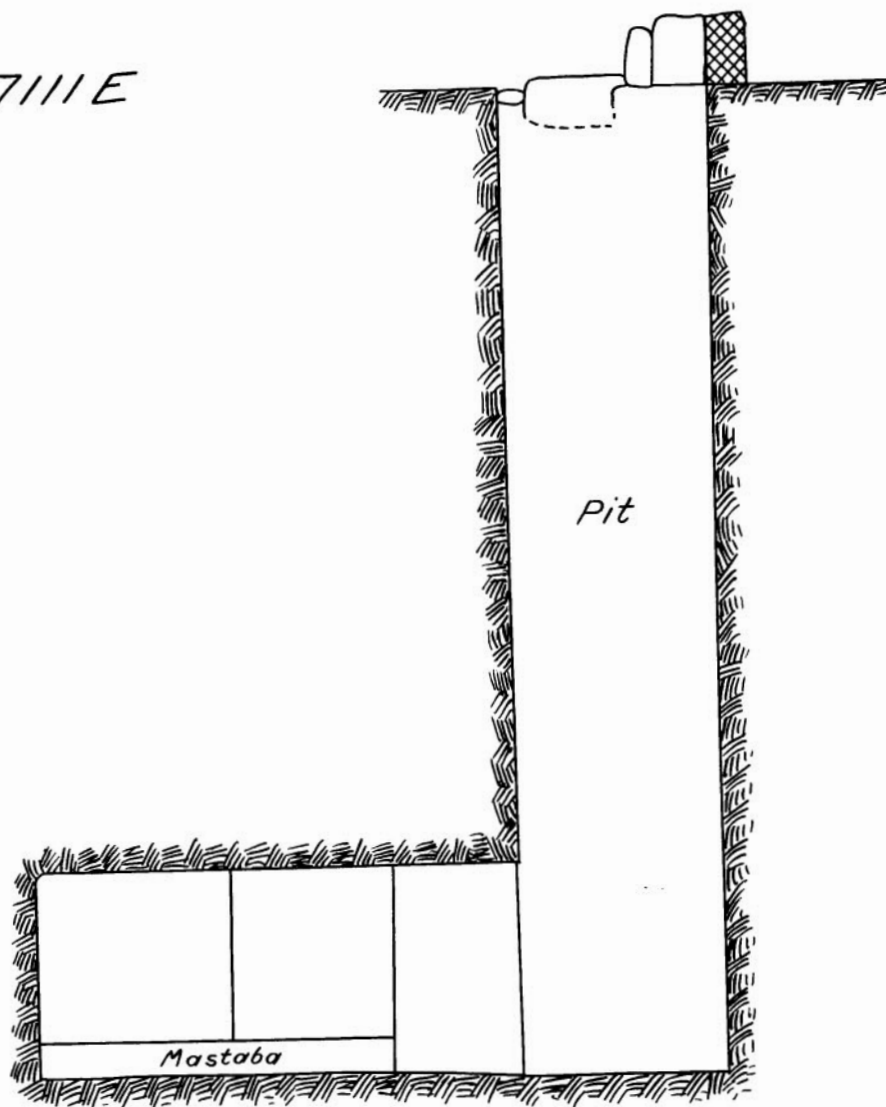

— G 7111 E —  
Section from West to East  
looking North.

0 — 1 m.

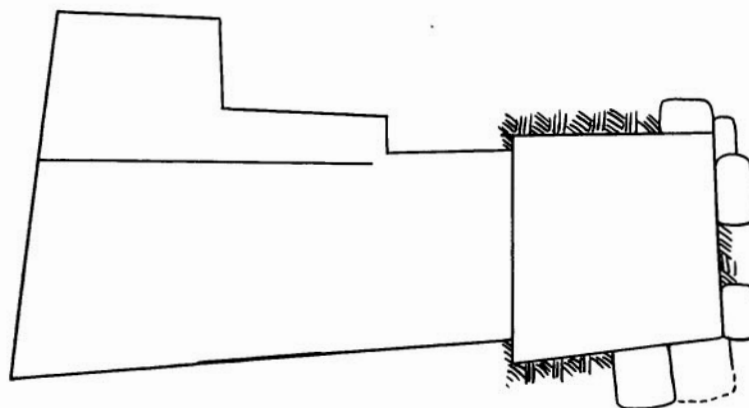

G 7112 A

G 7112 A  
25-1-311

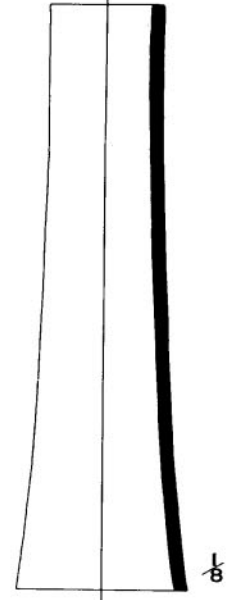

G 7112 A  
25-1-426

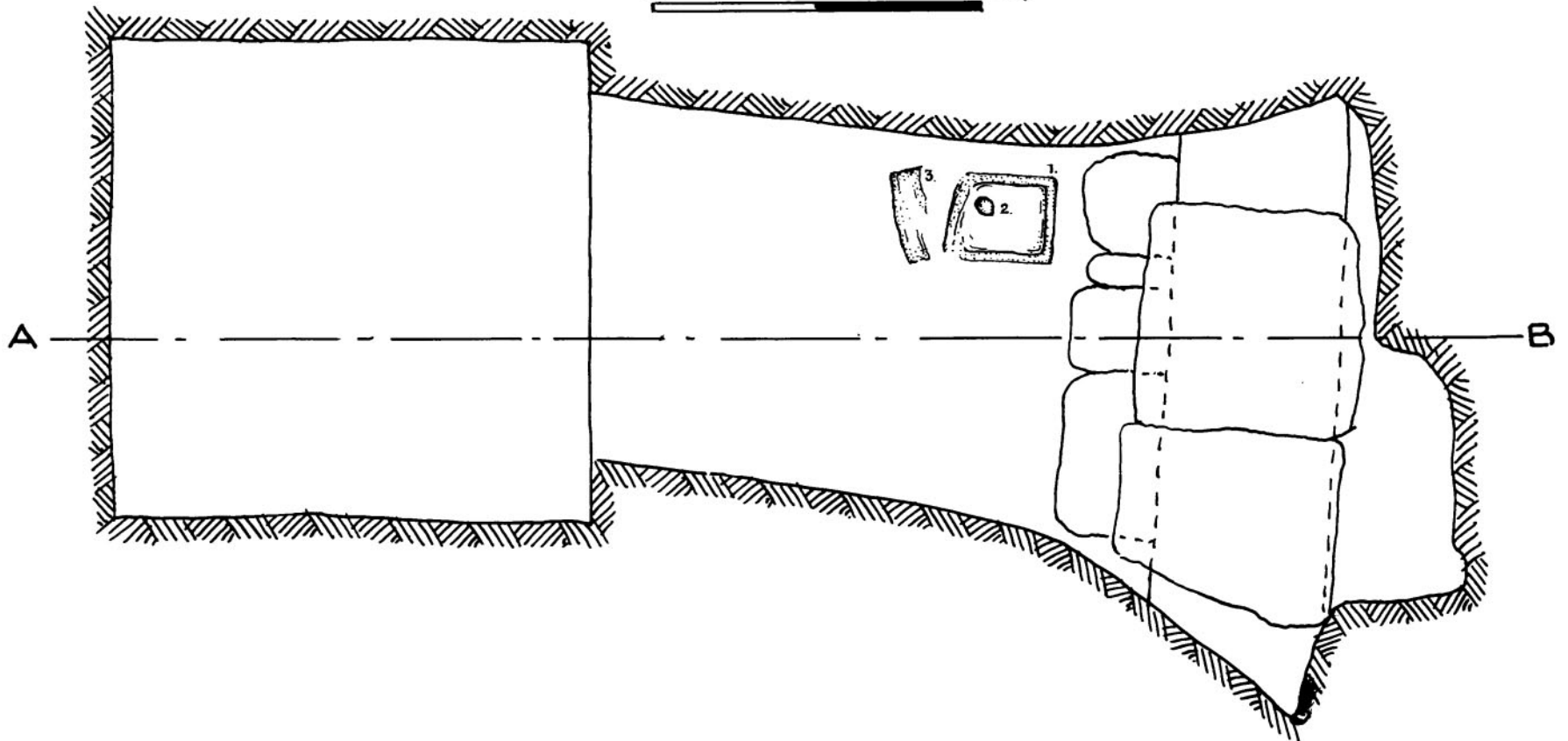
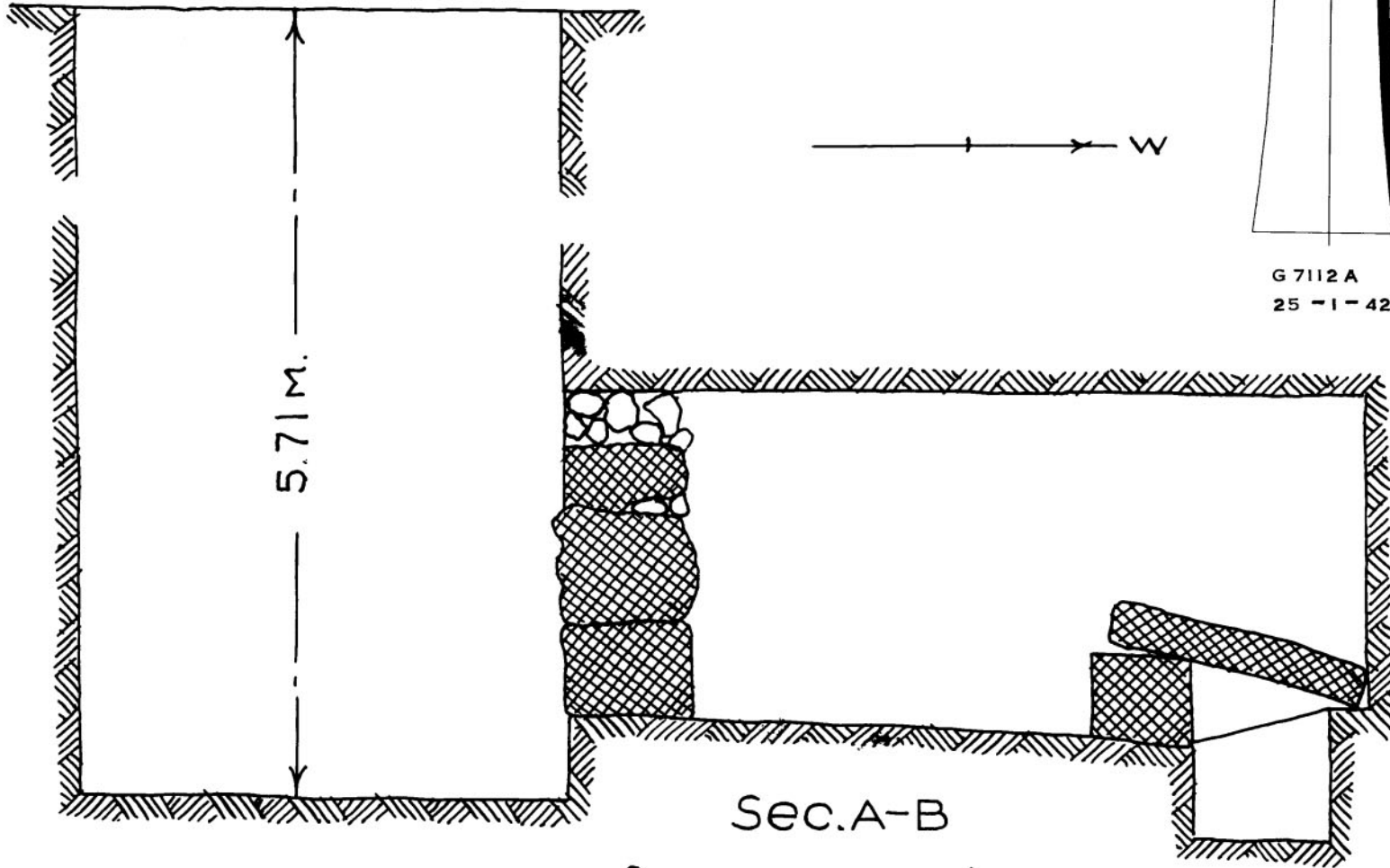

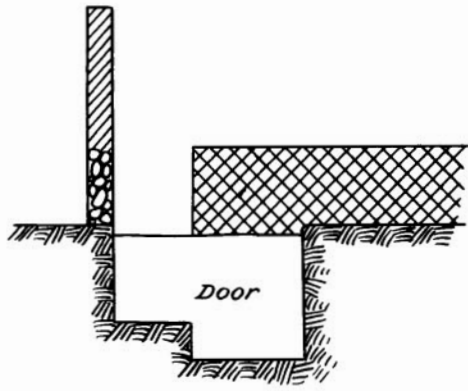

G 7112 B  
 Section from East to West  
 looking South



G 7112 C

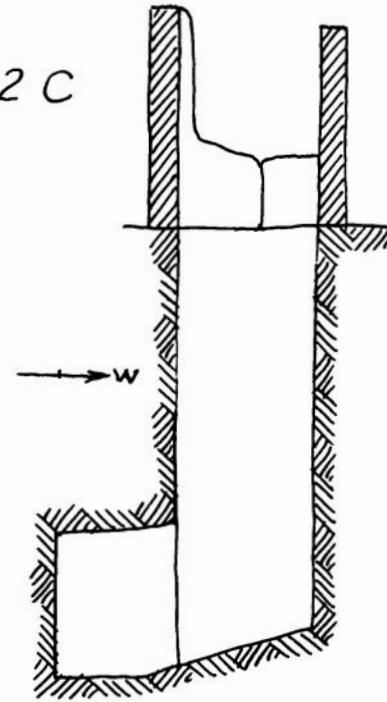

Sec. A-B

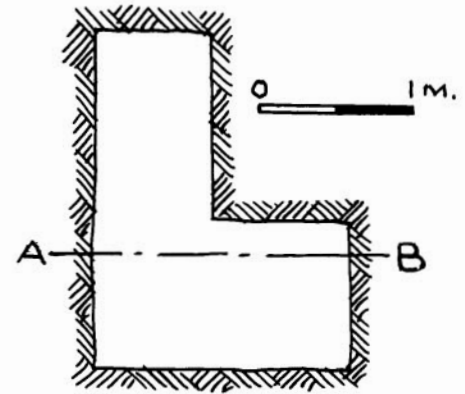

G 7112 D

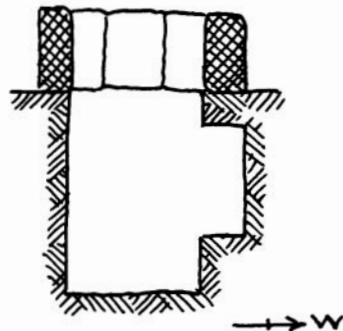

Sec. A-B

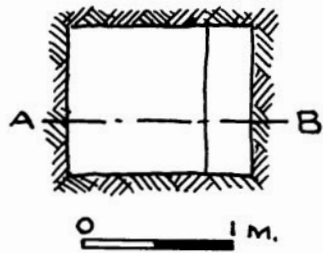

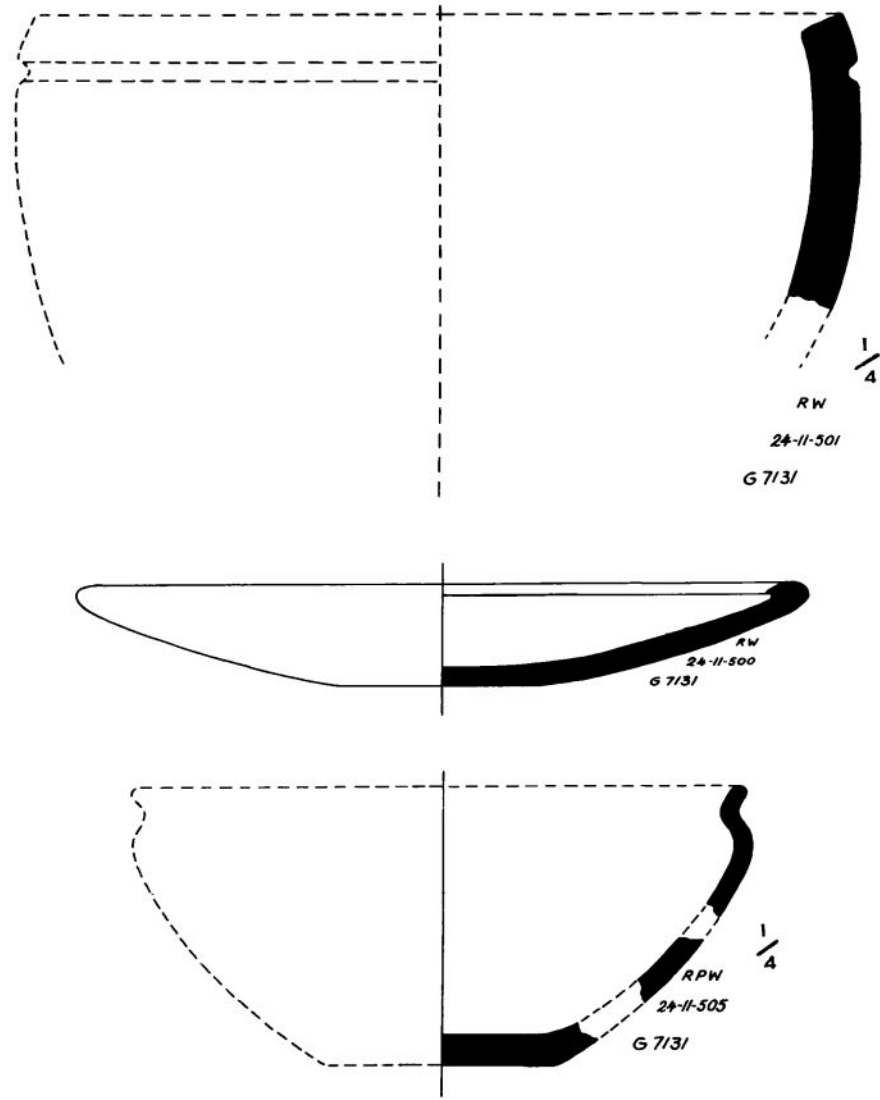

59. G 7131, pottery

G 7132 A

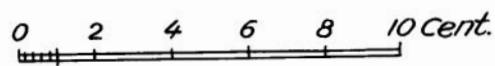
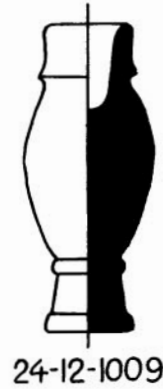
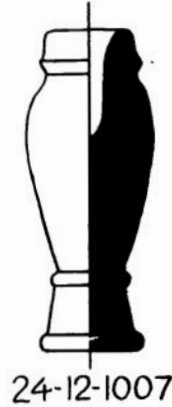
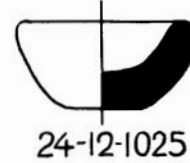
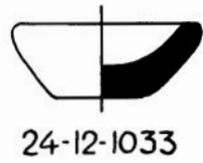
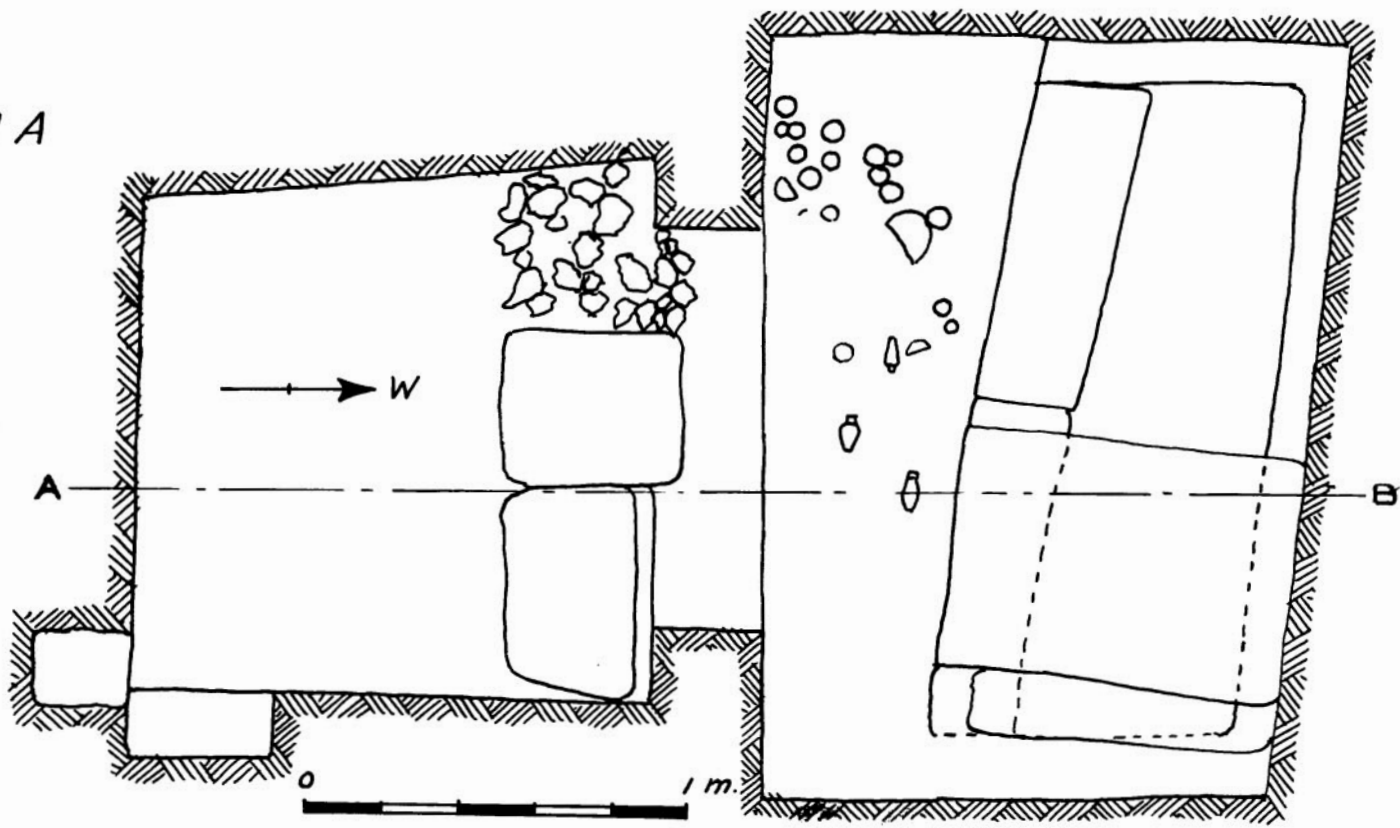

G 7132 A Chamber. Limestone

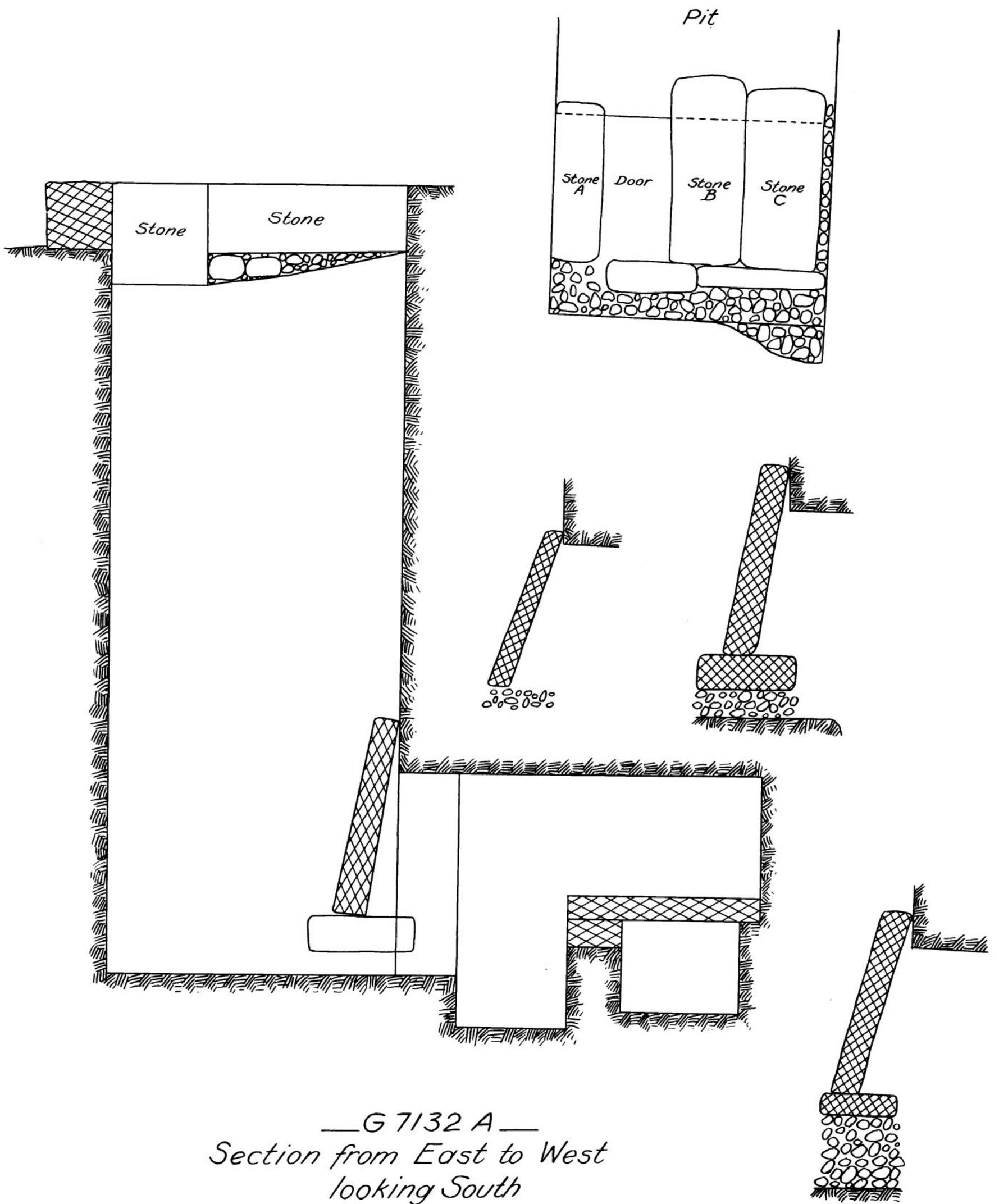

— G 7132 A —  
 Section from East to West  
 looking South

0 ————— 1 m.

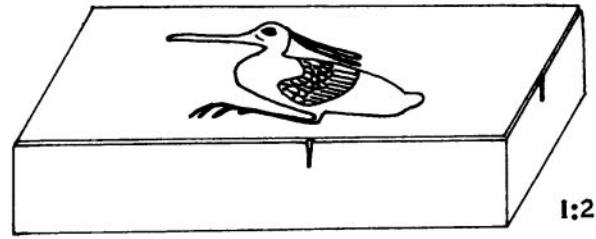

37-1-6  
G 7140 U

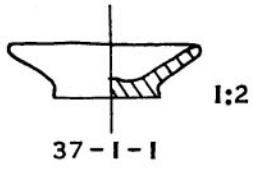

37-1-1

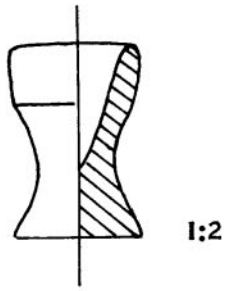

37-1-2

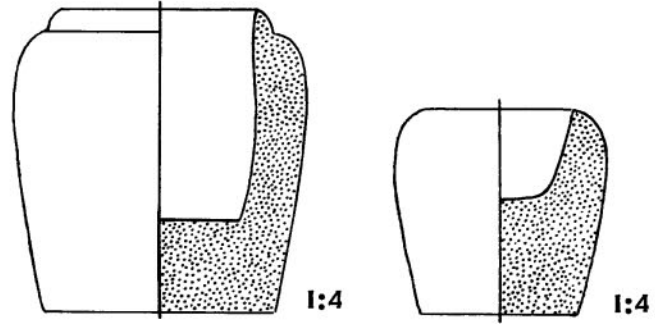

LIMESTONE  
G 7140 Z

26-3-147

26-3-194

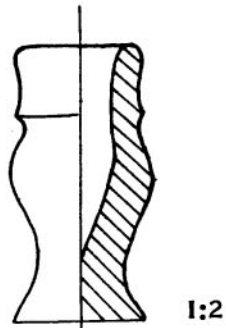

37-1-3

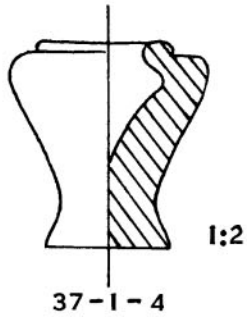

RBrW  
G 7140 X

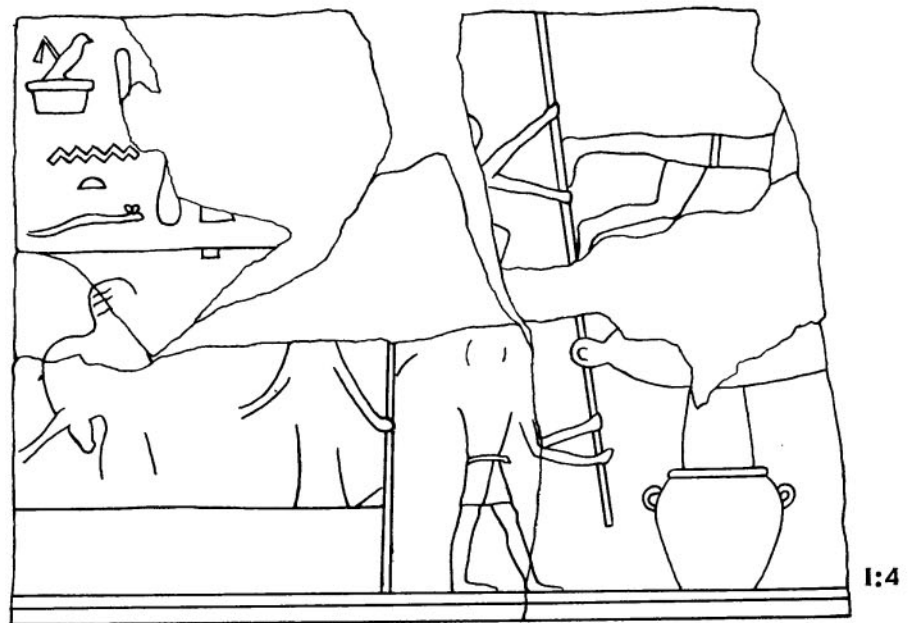

26-3-153

G 7140 Z



G 7132 B

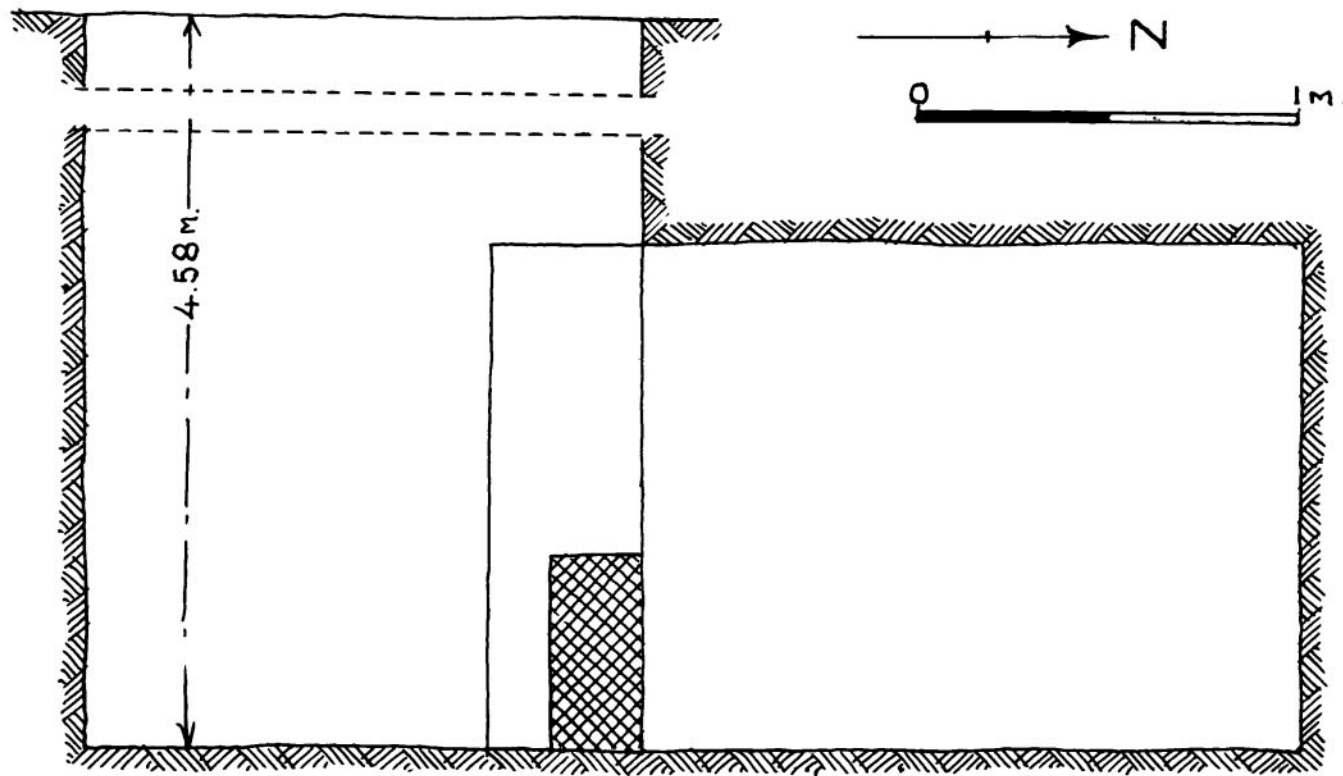

Sec. A-B

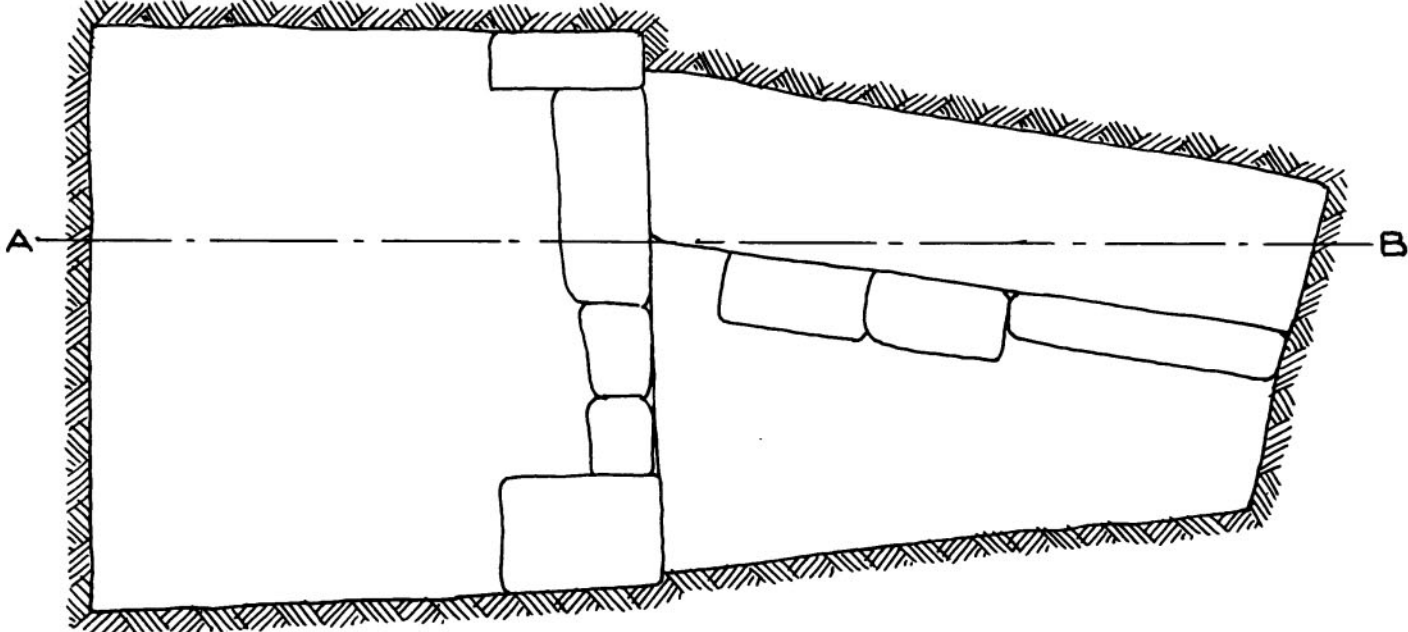

63. G 7132 B, plan and section

G 7133

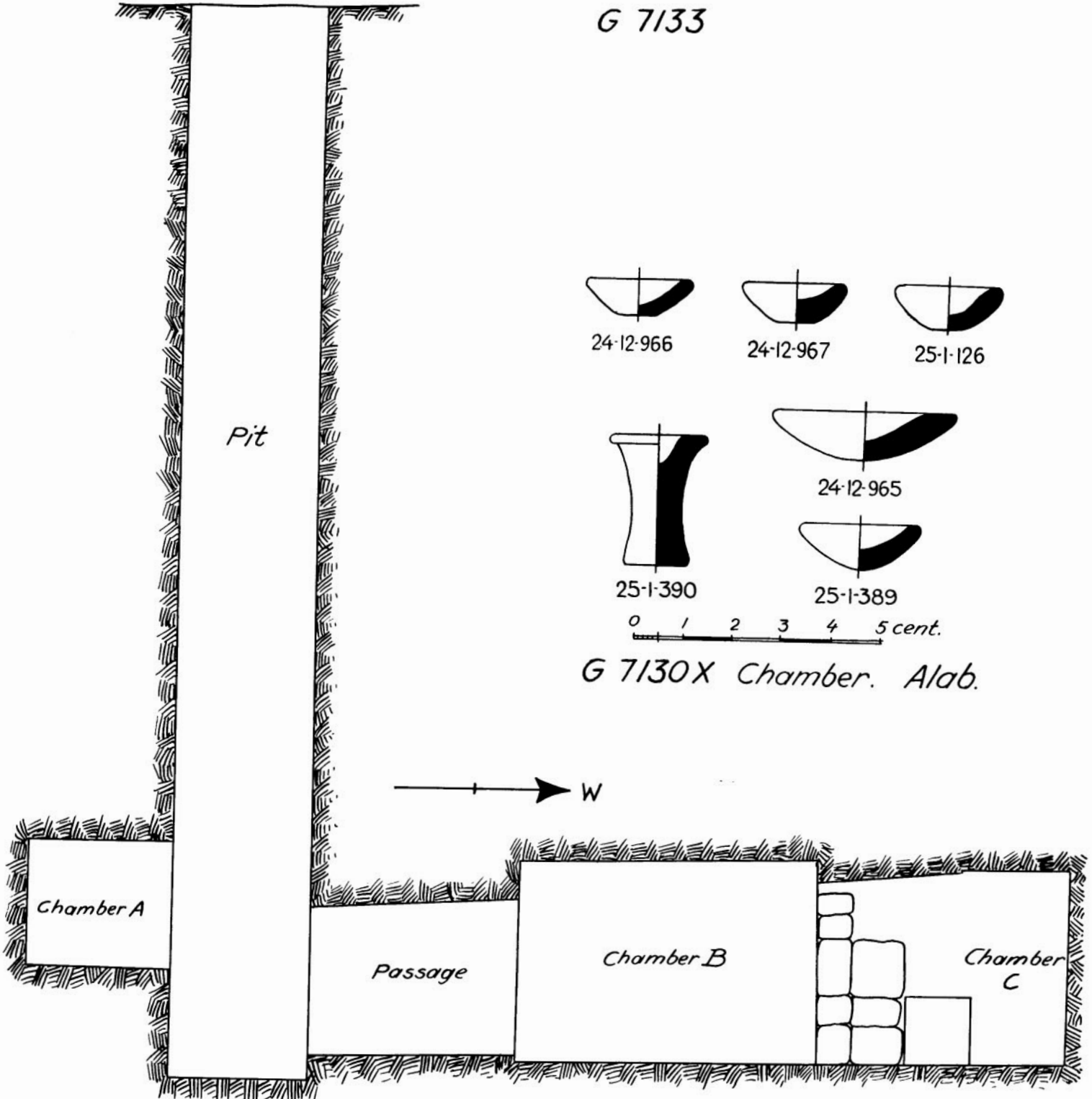

G 7130X Chamber. Alab.

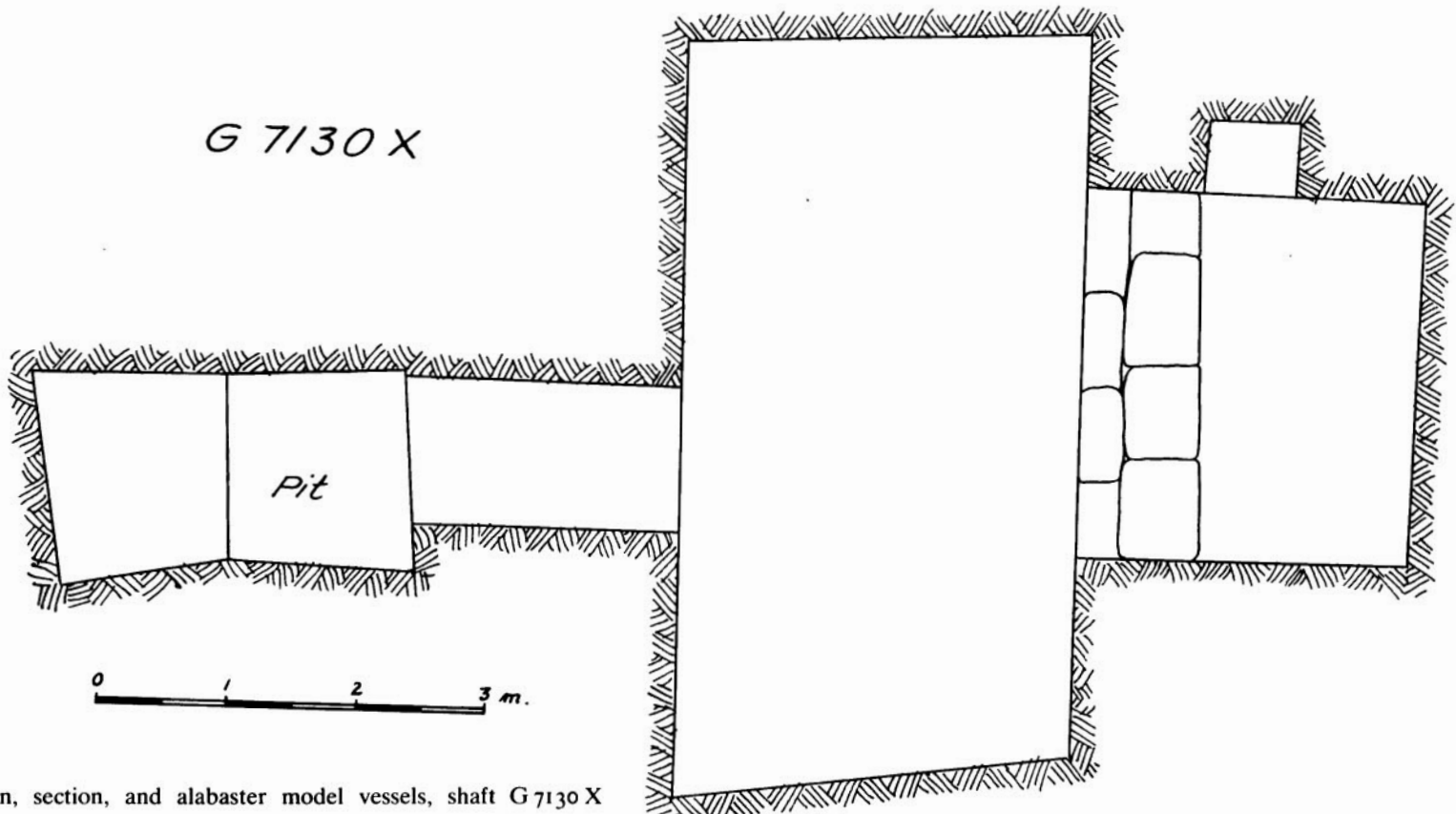

G 7133

G 7134

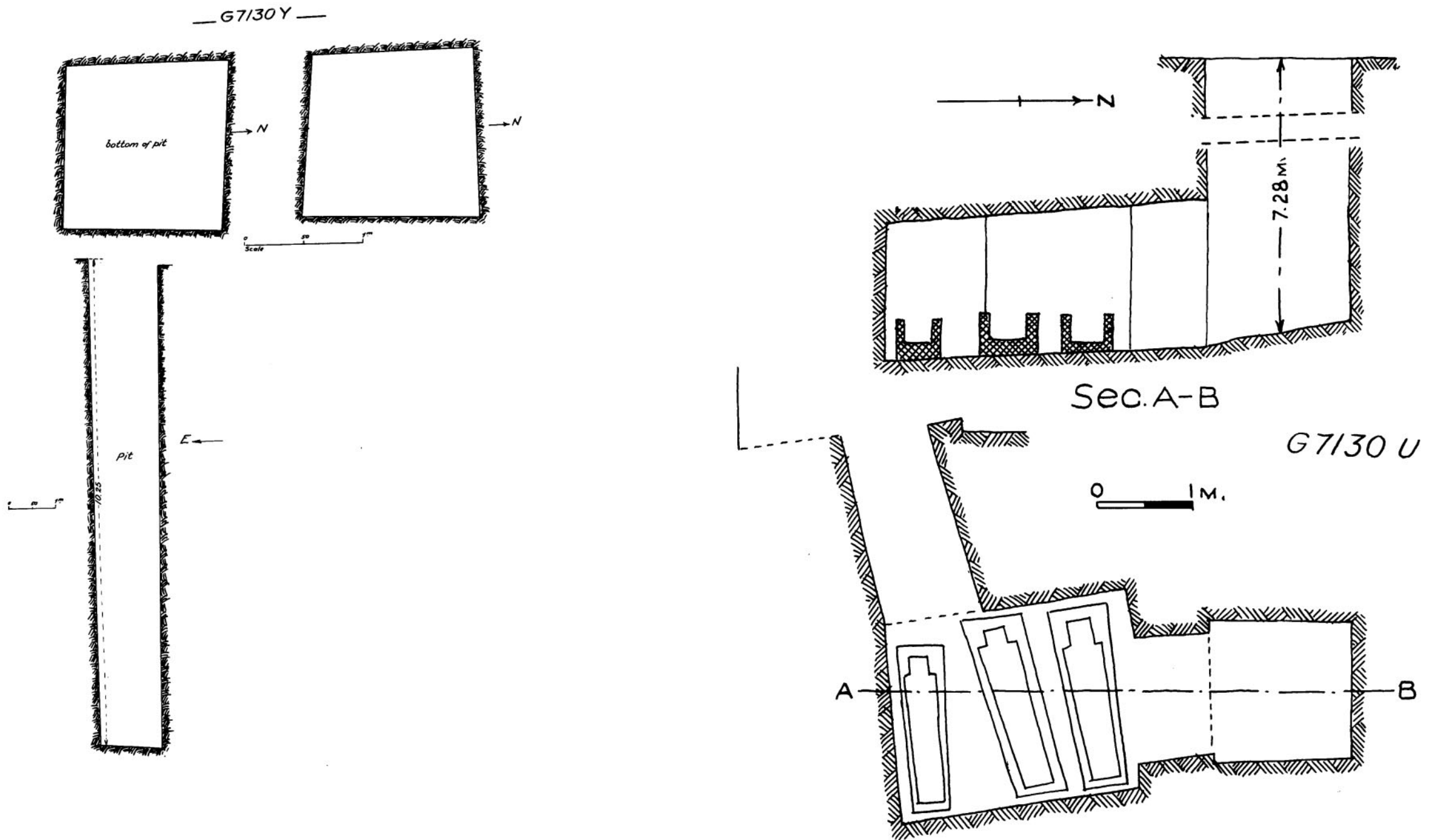

65. G 7133-7134: plan, section of G 7130 Y and G 7130 U

—G7130 Z—

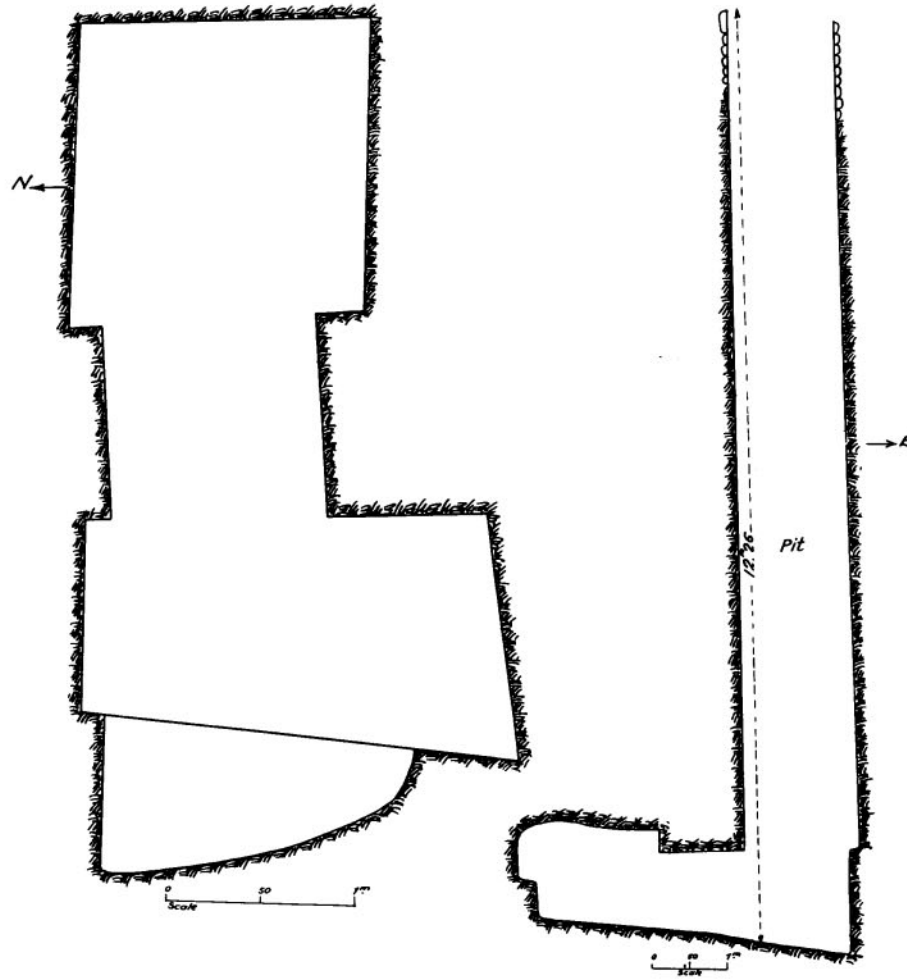

66. G 7130 Z, plan and section

G 7140 X

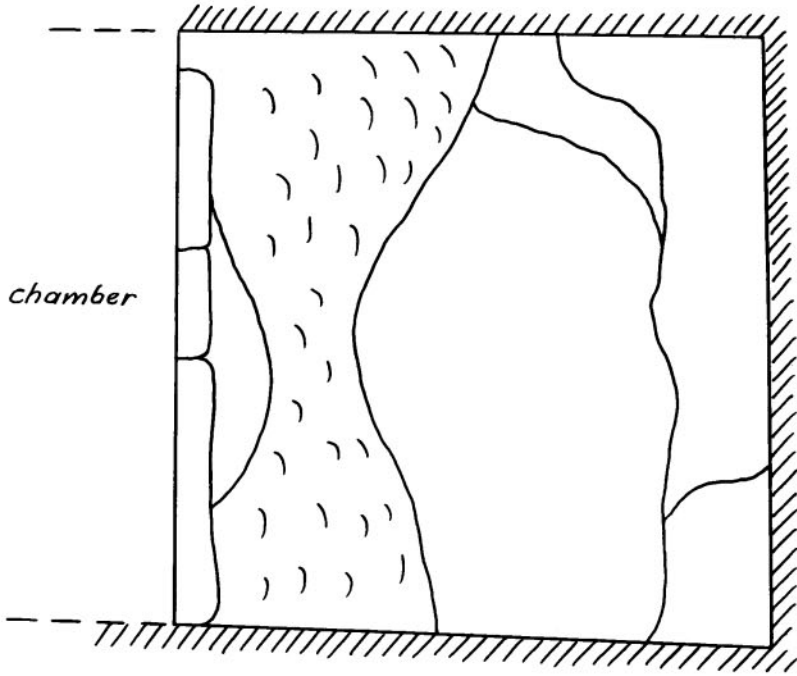
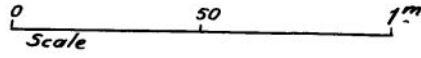

chamber

to top of gebel 3.95m  
to top of small stone masonry 4.55m.

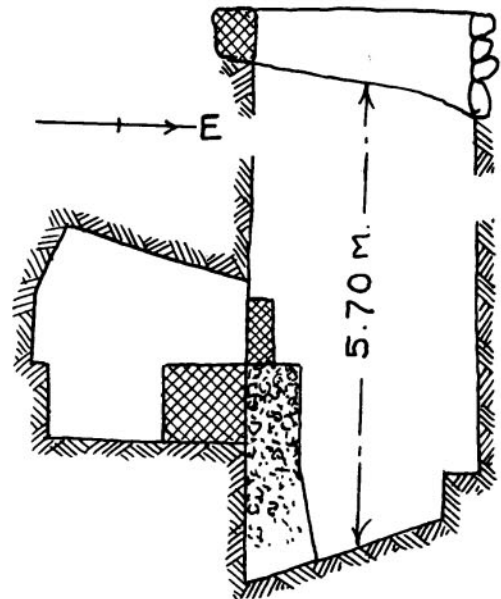

Sec. A-B

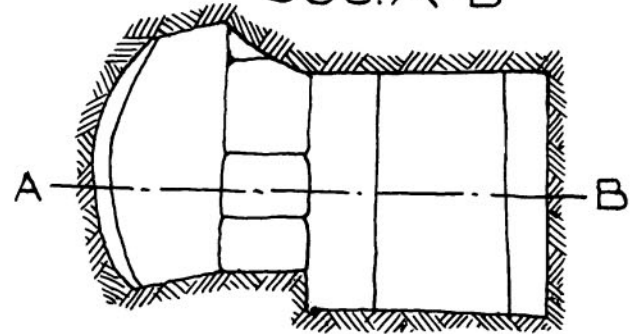

G 7140 X

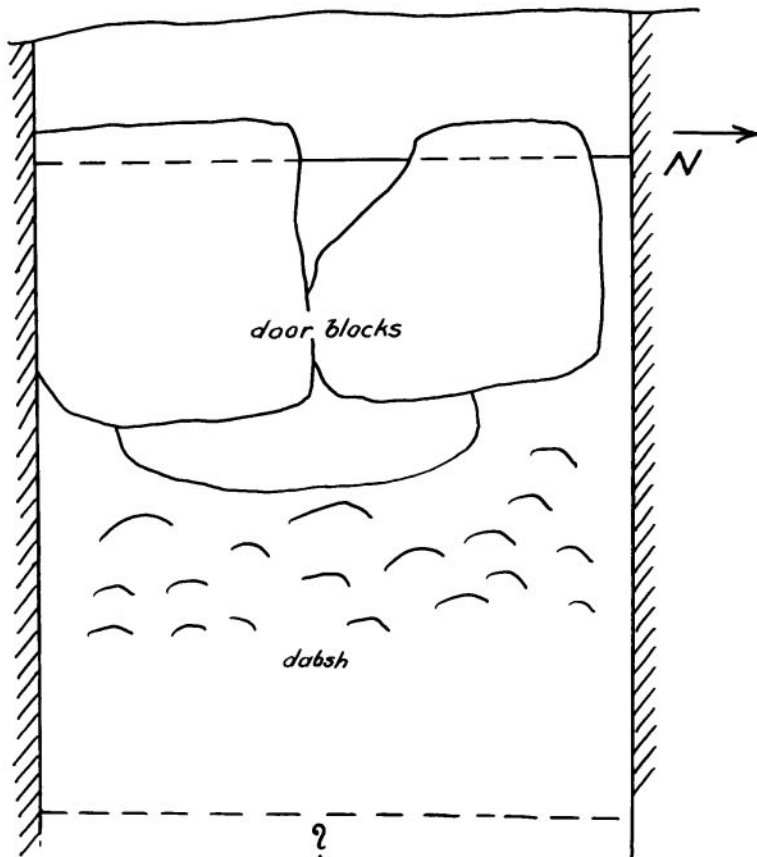

door blocks

dabsh

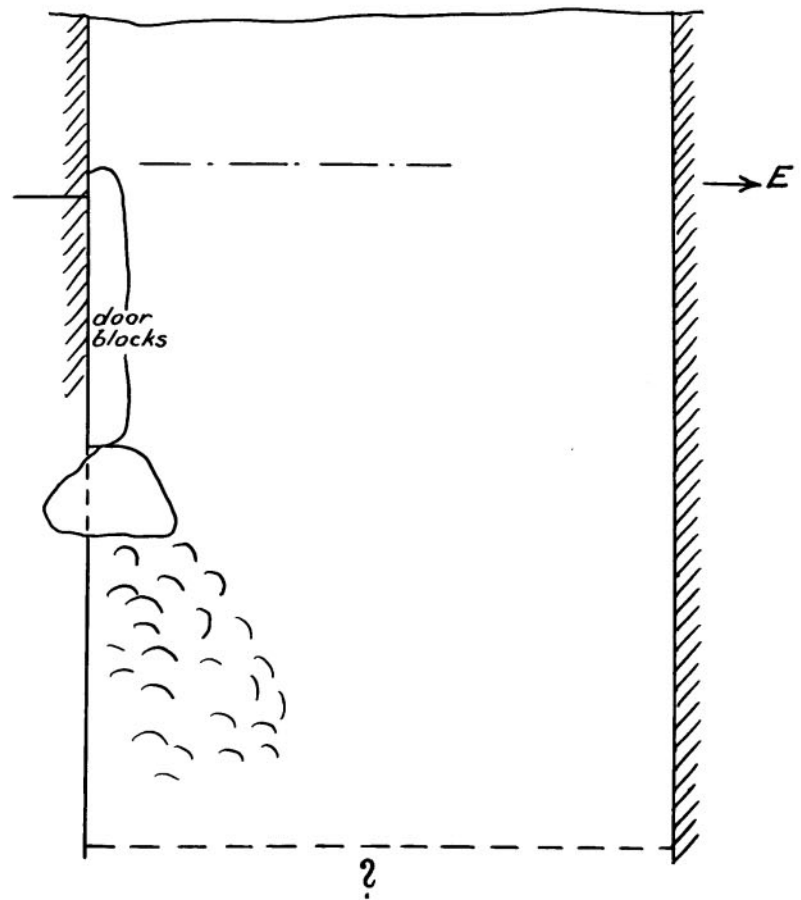

door blocks

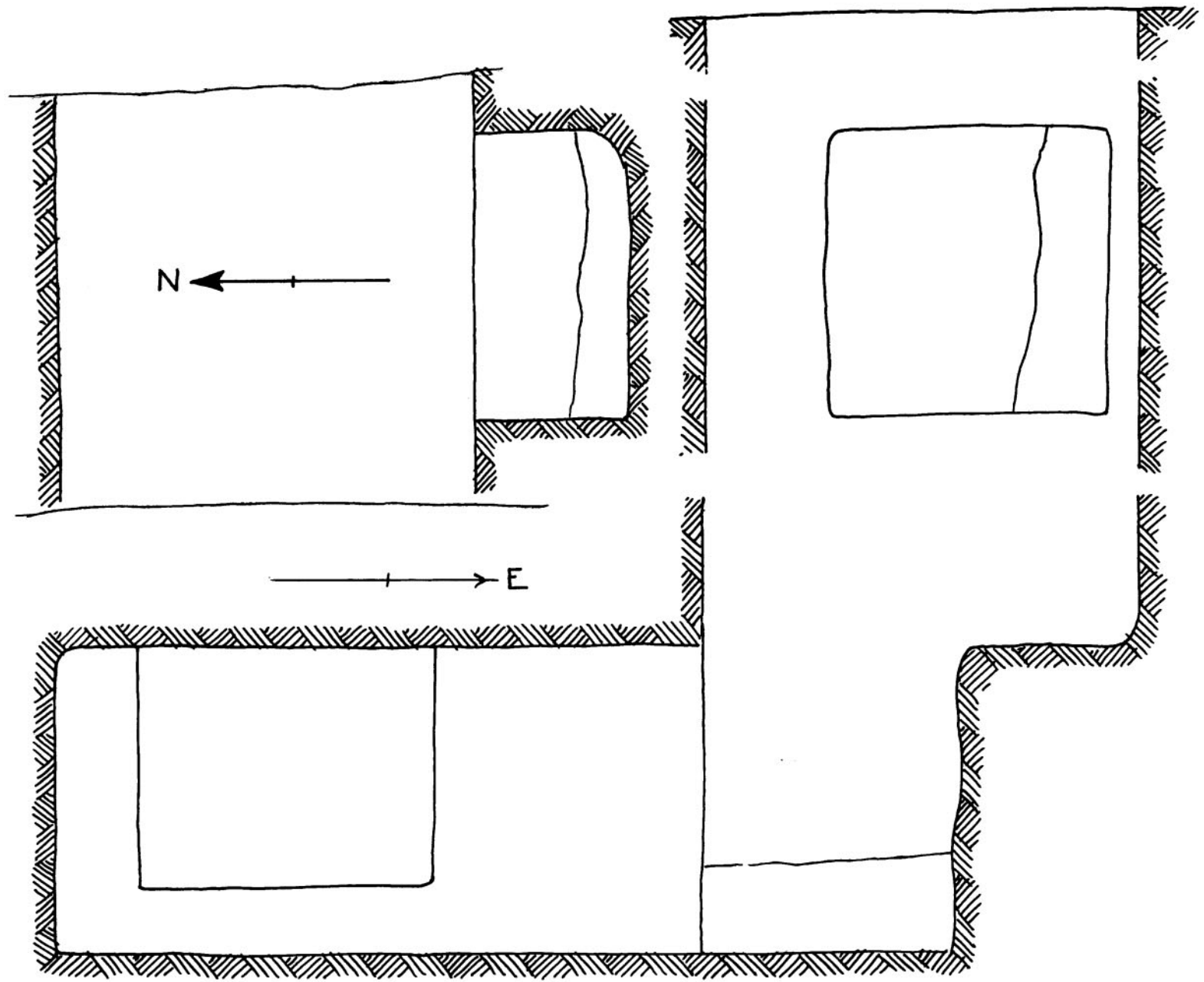

Sec. A-B

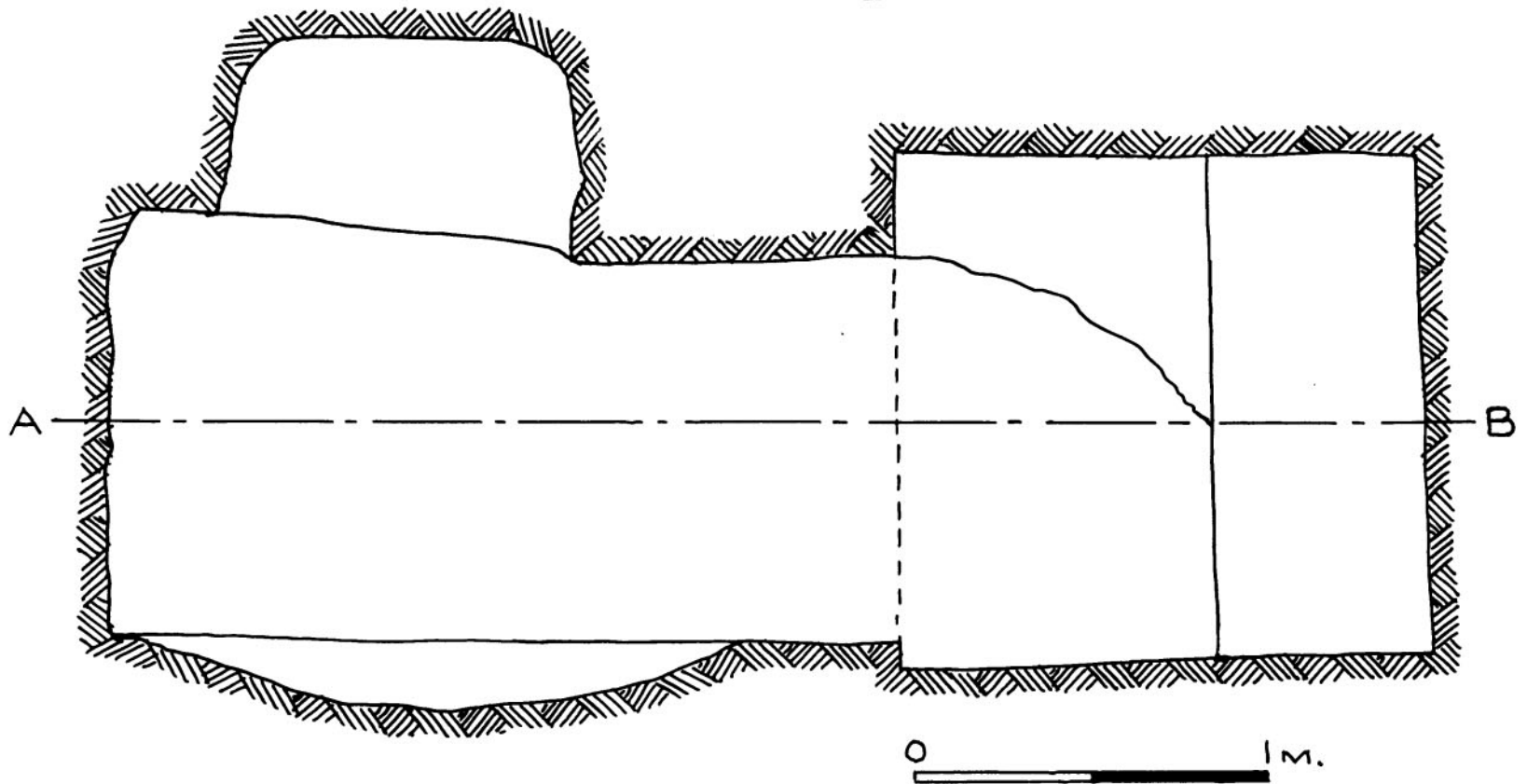

G 7140 Y

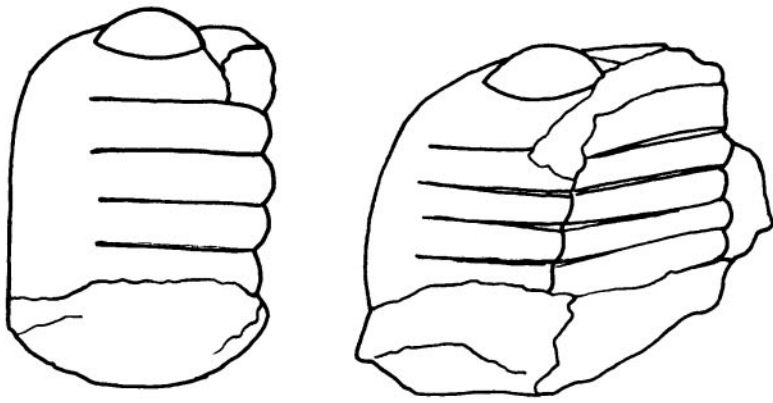

24-12-656  
G 7132 B PIT

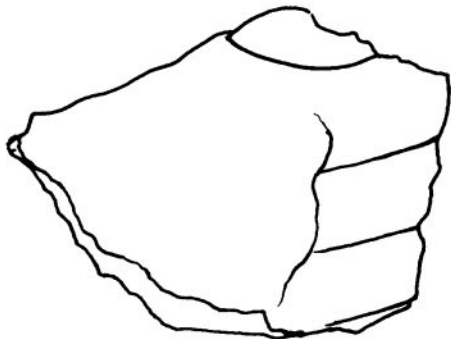

G 7132 B PIT  
24-12-657

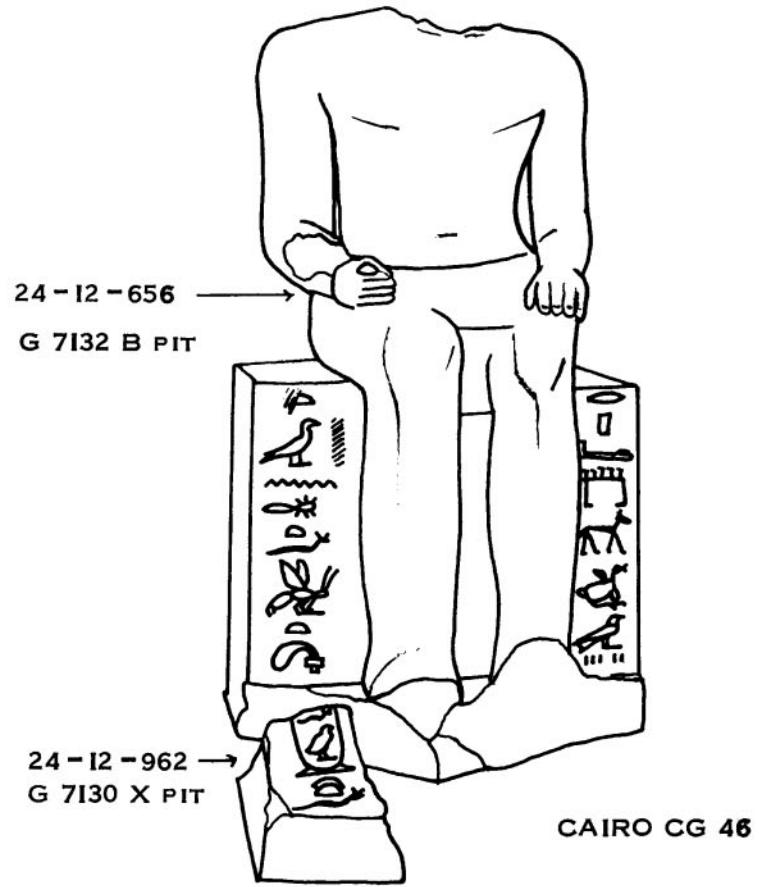

BOWL, INCISED TEXT  
25-II-311  
G 7112 A



G 7140 Z 23-3-124

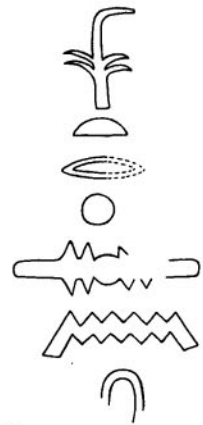

G 7130 X 24-12-867

5 CM.

69. Top left: diorite hands from statues

Top right: position of fragments assigned to Cairo statue CG 46

Bottom left: incised text on bowl, G 7112 A, from hand copy in register

Bottom right: texts from statue fragments, G 7140 Z and G 7130 X

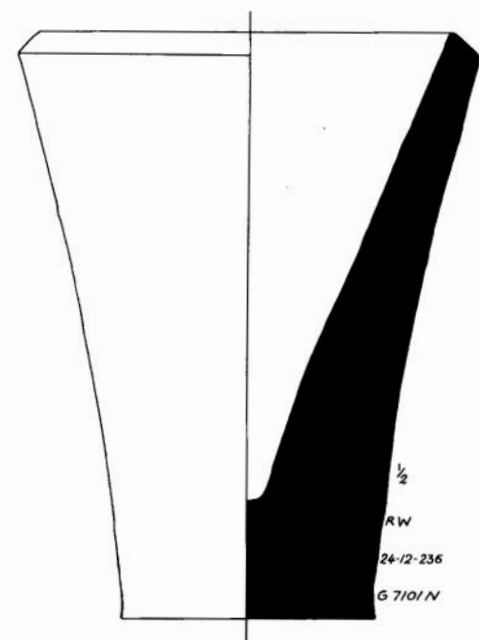
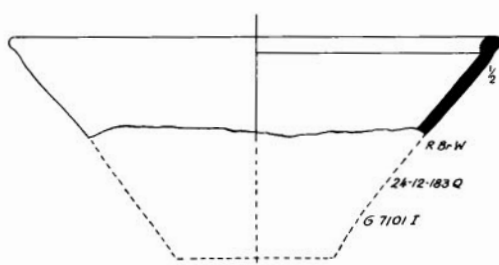
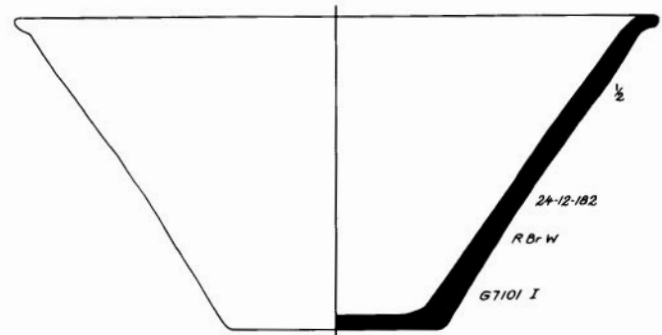
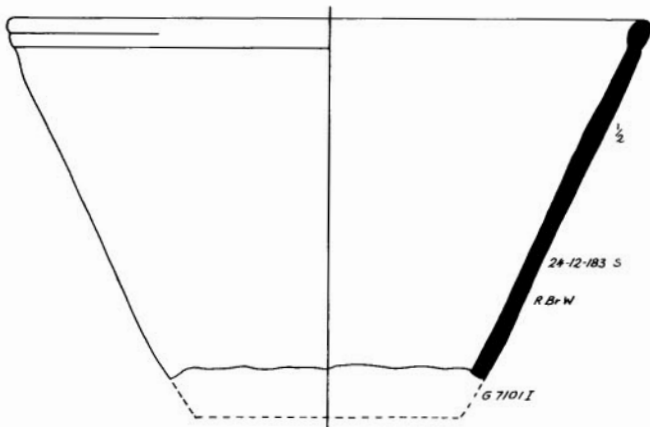
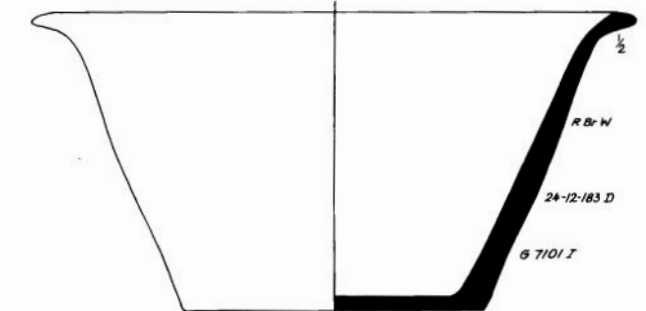
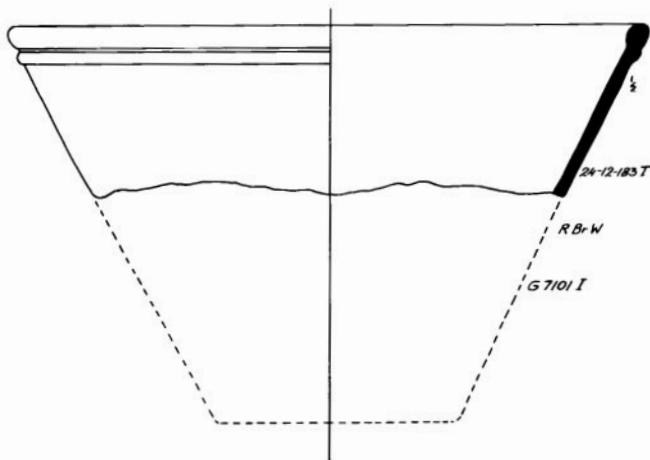
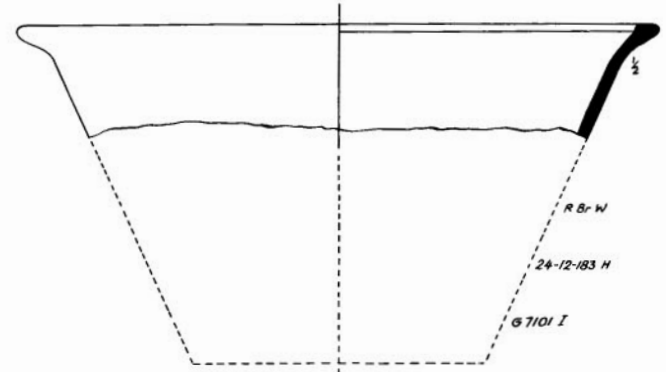
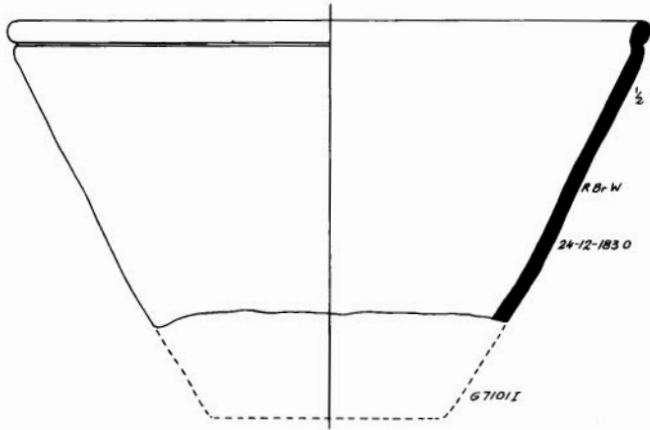
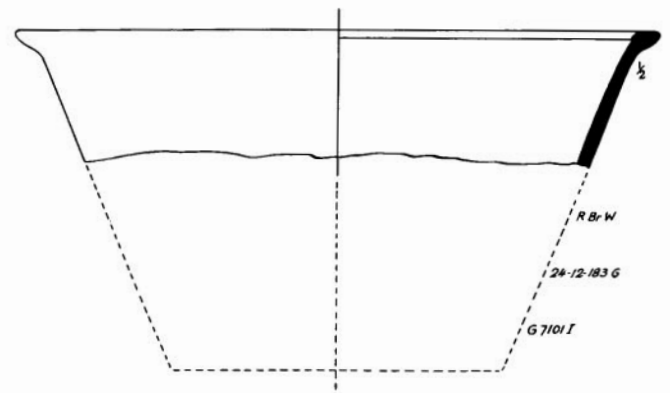
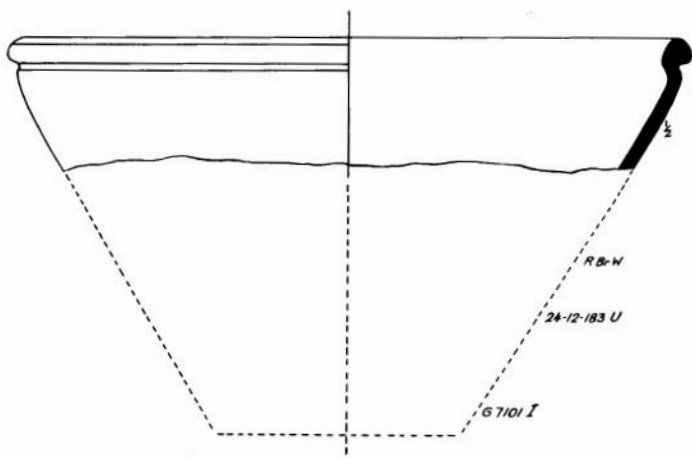

70. Addenda: G 7101-7102, Qar and Idu pottery; cf. *Giza Mastabas 2*



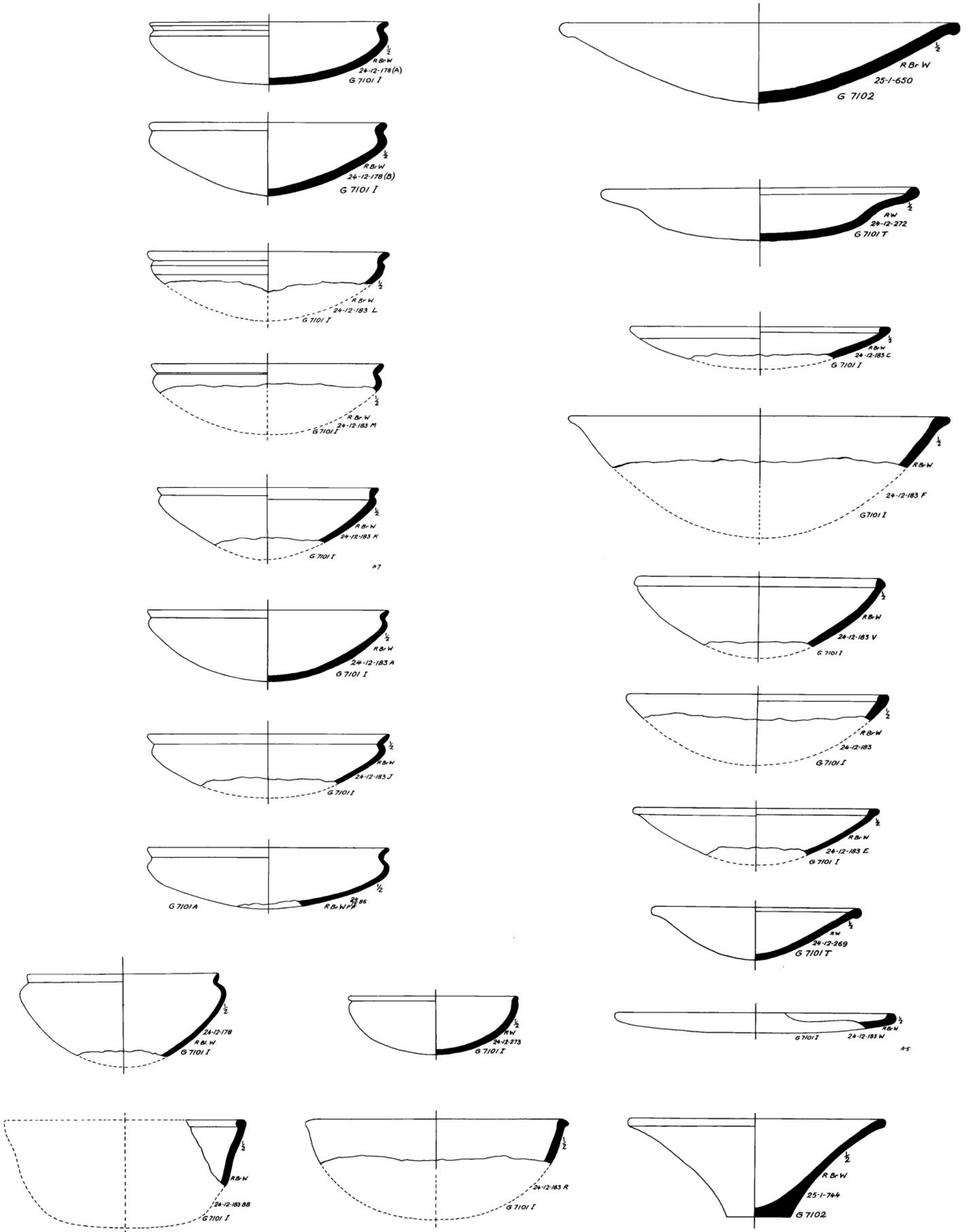

71. Addenda: G 7101-7102, Qar and Idu pottery; cf. *Giza Mastabas 2*

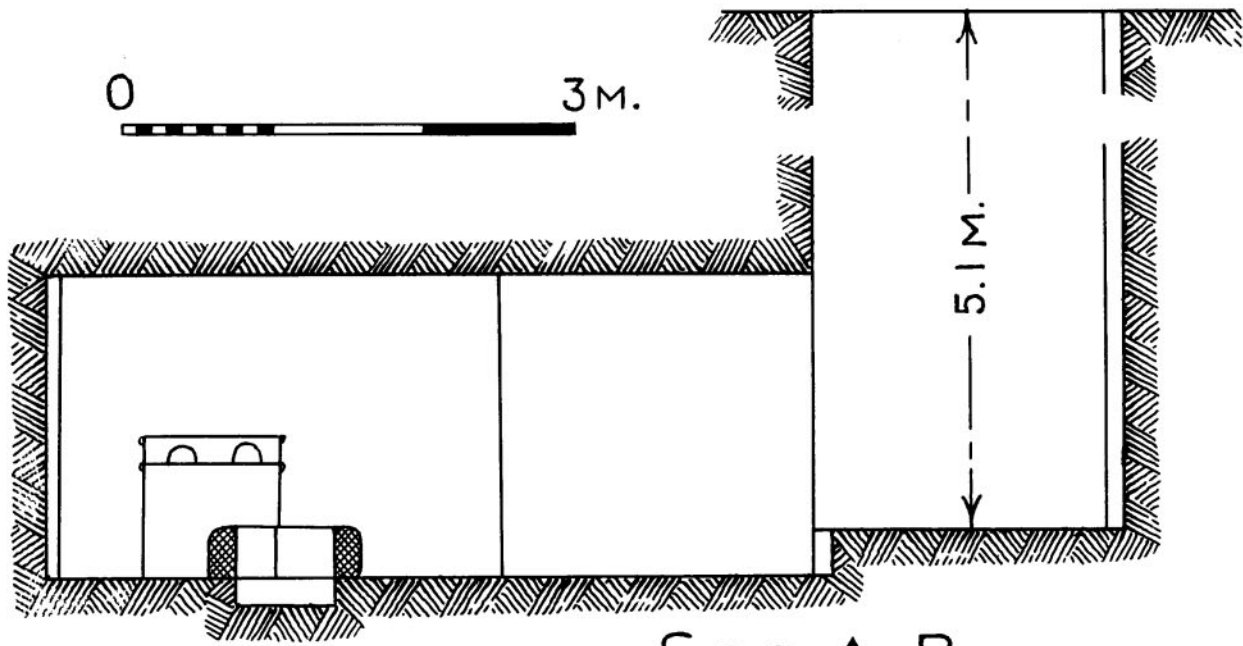

Sec. A-B

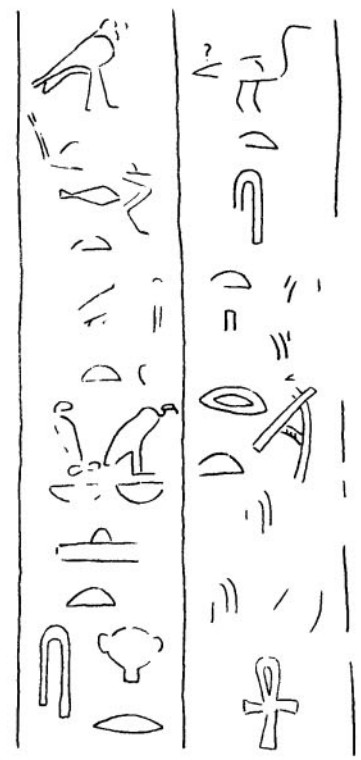

Pair statuette  
MFA 30.1456

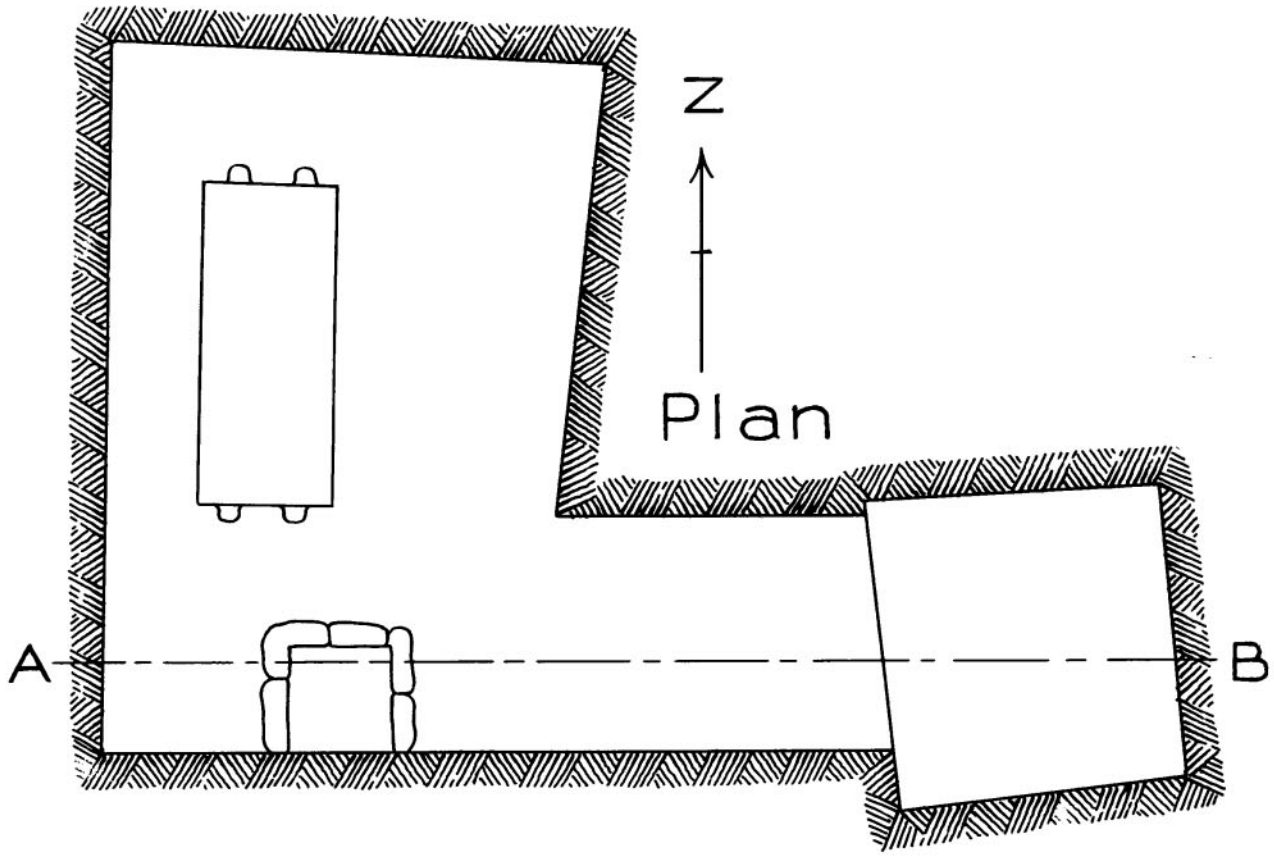

Plan

G 7530

